

TEHNOVEST

Strada Constantin cel Mare, Nr. 18
300265, Timisoara, Romania

office@tehnovest.ro
www.tehnovest.ro
mobil: 0727 724 831
tel. fix: 0356 100 440

TEHNOVEST

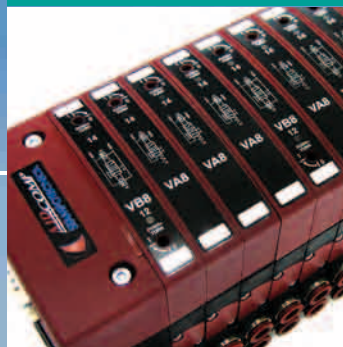

PNEUMATICA, REGULATOARE DE AER, DISTRIBUTOARE, CILINDRI
CATALOG 2015



CUPRINS

p.3-p.38 REGULATOARE DE AER

- p.4** REGULATOARE DE AER SERIA 035; 042; 050; 052; 075; 080; 095
- p.5** REGULATOARE DE AER SERIA 035 1/8"
- p.7** MICROREGULATOARE SERIA 038; 039
- p.12** SERIA MODULARA 042 1/4"
- p.19** REGULATOARE DE AER SERIA 050 3/8"; 052 1/2"
- p.36** PIESE DE SCHIMB
- p.38** GHID DE REFERINTE

p.39-p.70 DISTRIBUTOARE

- p.40** DISTRIBUTOARE SERIA 100
- p.43** DISTRIBUTOARE SERIA 110
- p.46** DISTRIBUTOARE SERIA 115
- p.48** DISTRIBUTOARE SERIA 120
- p.51** DISTRIBUTOARE SERIA 125 - 127
- p.58** DISTRIBUTOARE PANOU - BUTOANE
- p.59** DISTRIBUTOARE SERIA 130
- p.63** DISTRIBUTOARE SERIA 140
- p.66** GHID DE REFERINTE SERIA MP 160
- p.67** GHID PENTRU ACHIZITIONAREA DE COMPONENTE
- p.70** PIESE DE SCHIMB

p.71-p.96 CILINDRI

- p.72** CILINDRI SERIA 200
- p.74** CILINDRI SERIA 220; 221;222
- p.81** CILINDRI SERIA 225; 230
- p.85** CILINDRI SERIA 240
- p.88** CILINDRI SERIA 250
- p.94** SENZORI MAGNETICI
- p.96** KIT SERIA 250

TEHNOVEST

Firma S.C. TEHNOVEST AUTOMATIZARI SRL, cu un capital social de 500 RON, a fost înființată în anul 2004, fiind proprietatea a doi asociați, fiecare deținând câte 50% din părțile sociale.

TEHNOVEST AUTOMATIZĂRI

Împreună, căutăm soluții.

Prin dezvoltare permanentă, acceptare simultană a schimbărilor necesare și realizarea avantajului competitiv, răspundem întotdeauna provocărilor, asigurând astfel succesul operațiunilor desfășurate.

Gama de produse include produse standard și produse speciale nevoilor individuale ale clientului.

TEHNOVEST AUTOMATIZĂRI este focusată pe îndeplinirea nevoilor clientului și prin acest catalog dorim să oferim informații clare și exacte, fiind ușor și util celor interesați.

În acest catalog am selecționat o gamă diversă de produse care să sprijine clientul în alegerea produsului dorit, într-un timp foarte scurt.

Colaborând cu firma TEHNOVEST AUTOMATIZĂRI veți avea garanția achiziționării unor produse de calitate, prompt și la un preț corect.

INDEXUL PRODUSELOR



p.5 REGULATOARE DE AER
SERIA 035 1/8

p.7 MICROREGULATOARE DE AER
SERIA 038; 039 1/8 -1/4

p.12 REGULATOARE DE AER
SERIA 042 1/4

REGULATOARE DE AER INDEX



p.19 GRUP REGULATOR DE AER
SERIA 050 3/8; 052 1/2

p.28 GRUP REGULATOR DE AER
SERIA 075 1/2

p.31 GRUP REGULATOR DE AER
SERIA 080 3/4

p.34 GRUP REGULATOR DE AER
SERIA 095 1

p.35 ACCESORII / PIESE DE SCHIMB

REGULATOR DE AER

SERIA 035, 042, 050, 052, 075, 080, 095

FR	3/8"	050	20	08	R	PE	SS
PRODUS R - REGULATOR F - FILTRU MF - MICROFILTRU L - UNGATOR FR - FILTRU REGULATOR V3 - VENTIL - 3 CAI SU - VENTIL DE INCHIDERE AVP - VENTIL CU START LENT							TIPURI SPECIALE BATERIE - B INCARCARE CU VID - VL INCARCARE NIVEL MINIM - IL INCARCARE NIVEL MINIM SI MAXIM - IM PLIABIL - P
CONEXIUNI 1/8" = G1/8" 1/4" = G1/4" 3/8" = G3/8" 1/2" = G1/2" 3/4" = G3/4" 1" = G1"							PAHAR PROTECTIE PE EXTERIOR - PE PAHAR TRANSPARENT - TT
SERIA 035 042 050 052 075 080 095							VARIANTA PENTRU AER - R PENTRU APA - A
ELEMENT DE FILTRARE 5 = 5 microni 20 = 20 microni 80 = 80 microni 0,1 = 0,1 microni							
DOMENIU DE PRESIUNE 04 = 0÷4 Bari 06 = 0÷6 Bari (doar 035) 08 = 0÷8 Bari 12 = 0÷12 Bari							

F	1/8"	035	20	—	—	TT	SS	—
PRODUS								
MR - MICROREGULATOR								
F - FILTRU								
CONEXIUNI								
1/8" = G1/8"								
SERIA								
035								
ELEMENTE DE FILTRARE								
5 = 5 MICRON								
20 = 20 MICRON								
80 = 80 MICRON								
0,1 = 0,1 MICRON								
DOMENIU DE REGLARE								
06 = 0÷6 Bari								
TIPURI SPECIALE								
B - BATERIE								
P - PILOTATE								
PURJARE								
SS - MANUALA								
PAHAR								
TT - TRANSPARENT								
VARIANTE								
R = PENTRU AER								
A = PENTRU APA								

REGULATOARE DE AER

SERIA 035 1/8

MICROREGULATOR



COD	REFERINTE
TH035.01.00007	MR 1/8" 035 06 R
TH035.01.00006	MR 1/8" 035 06 A

MICROREGULATOR pentru Baterie



COD	REFERINTE
TH035.01.00005	MR 1/8" 035 06 R B
TH035.01.00003	MR 1/8" 035 06 A B

VENTIL MICROREGULATOR



COD	REFERINTE
TH035.01.00020	MR 1/8" 035 06 A P

FILTRU



COD	REFERINTE
TH035.02.00003	F 1/8" 035 5 TT SS
TH035.02.*****	F 1/8" 035 20 TT SS
TH035.02.00001	F 1/8" 035 80 (PENTRU APA)

MICROFILTRU



COD	REFERINTE
TH035.02.00002	MF 1/8" 035 0,1 TT

F+MF UNITE



COD	REFERINTE
TH035.09.00001	F 1/8" 035 5 TT SS+MF 1/8" 035 0,1 TT

ACCESORII

SRIA 035 1/8

MANOMETRU



COD	REFERINTE
THA35.01.00035	Manometru scale 0-6 bar
THA35.01.00025	Manometru 25 scale 0-12 bar

DOP



COD	REFERINTE
THB38.00.00018	Dop tehnopolimer 1/8

KIT

COD	REFERINTE
THC35.01.00018	Kit Seria 035

MR	1/4"	038	08	R	—	—	—	—
PRODUS								
MR - MICROREGULATOR								
CONEXIUNI								
1/8" = G1/8"								
1/4" = G1/4"								
SERIA								
038								
039								
GAMA DE PRESIUNE								
02 = 0÷2 Bari								
04 = 0÷4 Bari								
06 = 0÷6 Bari								
08 = 0÷8 Bari								
12 = 0÷12 Bari								
VARIANTA								
R - PENTRU AER								
A - PENTRU APA								
TESTAREA								
NG - ASAMBLATE SI TESTATE								
FARA UNGERE MANUALA								
COMPONENTE SPECIALE								
POM - COMPONENTE PLASTICE FARA INSERTII DE ALAMA								
INOX - INSERTIE INOX								
UTILIZARE								
2V = 2 CAI (VENTIL - 2 CAI)								
4V = 4 CAI (VENTIL - 4 CAI)								
TIPURI SPECIALE								
LC = COMPONENTE INTERNE SPECIALE								
FA = EVACUARE AER								
SRU = EVACUARE RAPIDA UNIDIRECTIONALA								

REGULATOARE DE AER

LINIA 038 1/4

MICROREGULATOR Seria 038



COD	REFERINTE
TH038.00.00011	MR 1/8" 038 02 R
TH038.00.00009	MR 1/8" 038 04 R
TH038.00.00024	MR 1/8" 038 08 R
TH038.00.00021	MR 1/8" 038 12 R
TH038.00.00045	MR 1/8" 038 02 A
TH038.00.00043	MR 1/8" 038 04 A
TH038.00.00031	MR 1/8" 038 08 A
TH038.00.00044	MR 1/8" 038 12 A
TH038.00.00033	MR 1/4" 038 02 R
TH038.00.00041	MR 1/4" 038 04 R
TH038.00.00032	MR 1/4" 038 08 R
TH038.00.00034	MR 1/4" 038 12 R
TH038.00.00035	MR 1/4" 038 02 A
TH038.00.00025	MR 1/4" 038 04 A
TH038.00.00019	MR 1/4" 038 08 A
TH038.00.00023	MR 1/4" 038 12 A

MICROREGULATOR Seria 038 + MANOMETRU



COD	REFERINTE
TH038.00.M0011	MR 1/8" 038 02 R + MANOMETRU 0-2,5bar
TH038.00.M0009	MR 1/8" 038 04 R + MANOMETRU 0-6 bar
TH038.00.M0024	MR 1/8" 038 08 R + MANOMETRU 0-12bar
TH038.00.M0021	MR 1/8" 038 12 R + MANOMETRU 0-12 bar
TH038.00.M0033	MR 1/4" 038 02 R + MANOMETRU 0-2,5 bar
TH038.00.M0041	MR 1/4" 038 04 R + MANOMETRU 0-6 bar
TH038.00.M0032	MR 1/4" 038 08 R + MANOMETRU 0-12 bar
TH038.00.M0034	MR 1/4" 038 12 R + MANOMETRU 0-12 bar

MICROREGULATOR Seria 038 + MANOMETRU + SUPORT



COD	REFERINTE
TH038.00.MS011	MR 1/8" 038 02 R + SUPORT + MAN. 0-2,5bar
TH038.00.MS009	MR 1/8" 038 04 R + SUPORT + MAN. 0-6 bar
TH038.00.MS024	MR 1/8" 038 08 R + SUPORT + MAN. 0-12bar
TH038.00.MS021	MR 1/8" 038 12 R + SUPORT + MAN. 0-12 bar
TH038.00.MS033	MR 1/4" 038 02 R + SUPORT + MAN. 0-2,5 bar
TH038.00.MS041	MR 1/4" 038 04 R + SUPORT + MAN. 0-6 bar
TH038.00.MS032	MR 1/4" 038 08 R + SUPORT + MAN. 0-12 bar
TH038.00.MS034	MR 1/4" 038 12 R + SUPORT + MAN. 0-12 bar

MICROREGULATOR "MR 038 SRU" (evacuare rapida unidirectionala)



COD	REFERINTE
TH038.00.00441	MR 1/4" 038 02 R SRU
TH038.00.00442	MR 1/4" 038 04 R SRU
TH038.00.00443	MR 1/4" 038 08 R SRU
TH038.00.00444	MR 1/4" 038 12 R SRU

REGULATOR DE AER

SERIA 038P 1/8 - 1/4

MICROREGULATOR Seria 038P + MANOMETRU + SUPORT



COD	REFERINTE
TH038.00.MS321	MR 1/8" 038P 02 R
TH038.00.MS322	MR 1/8" 038P 04 R
TH038.00.MS323	MR 1/8" 038P 08 R
TH038.00.MS324	MR 1/8" 038P 12 R
TH038.00.MS329	MR 1/4" 038P 02 R
TH038.00.MS330	MR 1/4" 038P 04 R
TH038.00.MS331	MR 1/4" 038P 08 R
TH038.00.MS332	MR 1/4" 038P 12 R

MICROREGULATOR Seria 038P FA RM

(microregulator de precizie si iesire constanta)



COD	REFERINTE
TH038.00.00311	MR 1/8" 038P 02 R FA RM
TH038.00.00312	MR 1/8" 038P 04 R FA RM
TH038.00.00313	MR 1/8" 038P 08 R FA RM
TH038.00.00314	MR 1/8" 038P 12 R FA RM
TH038.00.00301	MR 1/4" 038P 02 R FA RM
TH038.00.00302	MR 1/4" 038P 04 R FA RM
TH038.00.00303	MR 1/4" 038P 08 R FA RM
TH038.00.00304	MR 1/4" 038P 12 R FA RM

MICROREGULATOR Seria 038P (evacuare rapida unidirectionala)



COD	REFERINTE
TH038.00.00445	MR 1/4" 038P 02 R SRU
TH038.00.00446	MR 1/4" 038P 04 R SRU
TH038.00.00447	MR 1/4" 038P 08 R SRU
TH038.00.00448	MR 1/4" 038P 12 R SRU

ACCESORII

SERIA 038P 1/8 - 1/4

MANOMETRU



COD	REFERINTE
THA38.00.00114	MANOMETRU 1/8 D= 40mm scale 0-2,5 bar
THA38.00.00055	MANOMETRU 1/8 D= 40mm scale 0-6 bar
THA38.00.00026	MANOMETRU 1/8 D= 40mm scale 0-12 bar

SUPPORT



COD	REFERINTE
THC38.00.00069	Suport

DOP



COD	REFERINTE
THB38.00.00018	Tehnopolimer 1/8 dop

REGULATOARE DE AER

SERIA 038 1/8 - 1/4

SPECIAL MICROREGULATOR "LC"



COD	REFERINTE
TH038.00.00129	MR 1/8" 038 NG 02 A 2V POM LC
TH038.00.00130	MR 1/8" 038 NG 04 A 2V POM LC
TH038.00.00092	MR 1/8" 038 NG 08 A 2V POM LC
TH038.00.00131	MR 1/8" 038 NG 12 A 2V POM LC
TH038.00.00126	MR 1/8" 038 NG 02 A 4V POM LC
TH038.00.00127	MR 1/8" 038 NG 04 A 4V POM LC
TH038.00.00120	MR 1/8" 038 NG 08 A 4V POM LC
TH038.00.00128	MR 1/8" 038 NG 12 A 4V POM LC

ACCESORII

SERIA 035-1/8

MANOMETRU



COD	REFERINTE
THA38.00.00114	MANOMETRU 1/8 bore size 40 scale 0-2,5 bar
THA38.00.00055	MANOMETRU 1/8 bore size 40 scale 0-6 bar
THA38.00.00026	MANOMETRU 1/8 bore size 40 scale 0-12 bar

DOP



COD	REFERINTE
THB38.00.00018	Tehnopolimer 1/8 dop

SUPPORT



COD	REFERINTE
THC38.00.000069	Support

REGULATOARE DE AER

LINIE 038P 1/8-1/4

MICROREGULATOR Seria 038P (PLUS)



COD	REFERINTE
TH038.00.00321	MR 1/8" 038P 02 R
TH038.00.00322	MR 1/8" 038P 04 R
TH038.00.00323	MR 1/8" 038P 08 R
TH038.00.00324	MR 1/8" 038P 12 R
TH038.00.00325	MR 1/8" 038P 02 A
TH038.00.00326	MR 1/8" 038P 04 A
TH038.00.00327	MR 1/8" 038P 08 A
TH038.00.00328	MR 1/8" 038P 12 A
TH038.00.00329	MR 1/4" 038P 02 R
TH038.00.00330	MR 1/4" 038P 04 R
TH038.00.00331	MR 1/4" 038P 08 R
TH038.00.00332	MR 1/4" 038P 12 R
TH038.00.00333	MR 1/4" 038P 02 A
TH038.00.00334	MR 1/4" 038P 04 A
TH038.00.00335	MR 1/4" 038P 08 A
TH038.00.00336	MR 1/4" 038P 12 A

MICROREGULATOR Seria 038P + MANOMETRU



COD	REFERINTE
TH038.00.M0321	MR 1/8" 038P 02 R + MANOMETRU 0-2,5 bar
TH038.00.M0322	MR 1/8" 038P 04 R + MANOMETRU 0-6 bar
TH038.00.M0323	MR 1/8" 038P 08 R + MANOMETRU 0-12bar
TH038.00.M0324	MR 1/8" 038P 12 R + MANOMETRU 0-12 bar
TH038.00.M0329	MR 1/4" 038P 02 R + MANOMETRU 0-2,5 bar
TH038.00.M0330	MR 1/4" 038P 04 R + MANOMETRU 0-6 bar
TH038.00.M0331	MR 1/4" 038P 08 R + MANOMETRU 0-12 bar
TH038.00.M0332	MR 1/4" 038P 12 R + MANOMETRU 0-12 bar

REGULATOARE DE AER

SERIA 039 1/8 - 1/4

MICROREGULATOR MR 039



COD	REFERINTE
TH039.00.00001	MR 1/8" 039 02 R
TH039.00.00002	MR 1/8" 039 04 R
TH039.00.00003	MR 1/8" 039 08 R
TH039.00.00004	MR 1/8" 039 12 R
TH039.00.00201	MR 1/8" 039 02 A
TH039.00.00202	MR 1/8" 039 04 A
TH039.00.00203	MR 1/8" 039 08 A
TH039.00.00204	MR 1/8" 039 12 A
TH039.00.00401	MR 1/4" 039 02 R
TH039.00.00402	MR 1/4" 039 04 R
TH039.00.00403	MR 1/4" 039 08 R
TH039.00.00404	MR 1/4" 039 12 R
TH039.00.00601	MR 1/4" 039 02 A
TH039.00.00602	MR 1/4" 039 04 A
TH039.00.00603	MR 1/4" 039 08 A
TH039.00.00604	MR 1/4" 039 12 A

MICROREGULATOR Seria 039 + MANOMETRU



COD	REFERINTE
TH039.00.M0001	MR 1/8" 039 02 R + MANOMETRU
TH039.00.M0002	MR 1/8" 039 04 R + MANOMETRU
TH039.00.M0003	MR 1/8" 039 08 R + MANOMETRU
TH039.00.M0004	MR 1/8" 039 12 R + MANOMETRU
TH039.00.M0401	MR 1/4" 039 02 R + MANOMETRU
TH039.00.M0402	MR 1/4" 039 04 R + MANOMETRU
TH039.00.M0403	MR 1/4" 039 08 R + MANOMETRU
TH039.00.M0404	MR 1/4" 039 12 R + MANOMETRU

MICROREGULATOR Seria 039 (FA) (precizie)



COD	REFERINTE
TH039.00.00701	MR 1/8" 039 02 R FA
TH039.00.00702	MR 1/8" 039 04 R FA
TH039.00.00703	MR 1/8" 039 08 R FA
TH039.00.00704	MR 1/8" 039 12 R FA
TH039.00.00801	MR 1/4" 039 02 R FA
TH039.00.00802	MR 1/4" 039 04 R FA
TH039.00.00803	MR 1/4" 039 08 R FA
TH039.00.00804	MR 1/4" 039 12 R FA

MICROREGULATOR Seria 039 + MANOMETRU + SUPORT



COD	REFERINTE
TH039.00.MS001	MR 1/8" 039 02 R
TH039.00.MS002	MR 1/8" 039 04 R
TH039.00.MS003	MR 1/8" 039 08 R
TH039.00.MS004	MR 1/8" 039 12 R
TH039.00.MS401	MR 1/4" 039 02 R
TH039.00.MS402	MR 1/4" 039 04 R
TH039.00.MS403	MR 1/4" 039 08 R
TH039.00.MS404	MR 1/4" 039 12 R

MICROREGULATOR Seria 039 SRU^{rapida} (unidirectional)



COD	REFERINTE
TH039.00.00441	MR 1/4" 039 02 R SRU
TH039.00.00442	MR 1/4" 039 04 R SRU
TH039.00.00443	MR 1/4" 039 08 R SRU
TH039.00.00444	MR 1/4" 039 12 R SRU

MICROREGULATOR Seria 039 INOX



COD	REFERINTE
TH039.00.00227	MR 1/4" 039 02 A inox 2V FG
TH039.00.00228	MR 1/4" 039 04 A inox 2V FG
TH039.00.00229	MR 1/4" 039 08 A inox 2V FG
TH039.00.00230	MR 1/4" 039 12 A inox 2V FG

ACCESORII

SERIA 039 1/8 - 1/4

MANOMETRU



COD	REFERINTE
THA38.00.00114	MANOMETRU 1/8 D= 40mm scale 0-2,5 bar
THA38.00.00055	MANOMETRU 1/8 D= 40mm scale 0-6 bar
THA38.00.00026	MANOMETRU 1/8 D= 40mm scale 0-12 bar

SUPPORT



COD	REFERINTE
THC38.00.000069	Suport

DOP



COD	REFERINTE
THB38.00.00018	Tehnopolimer 1/8 dop

SERIA MODULARA 042, 1/4"

V3+FR+PA+SV+AVP+L

SUPPORT DE FIXARE PE PERETE

SUPPORT DE FIXARE T

BUTON DE BLOCARE

VENTIL 3 CĂI OUT-OFF
VENTIL 3/2 ON-OFF

ELEMENT FILTRANT

PURJA SEMIAUTOMATICA

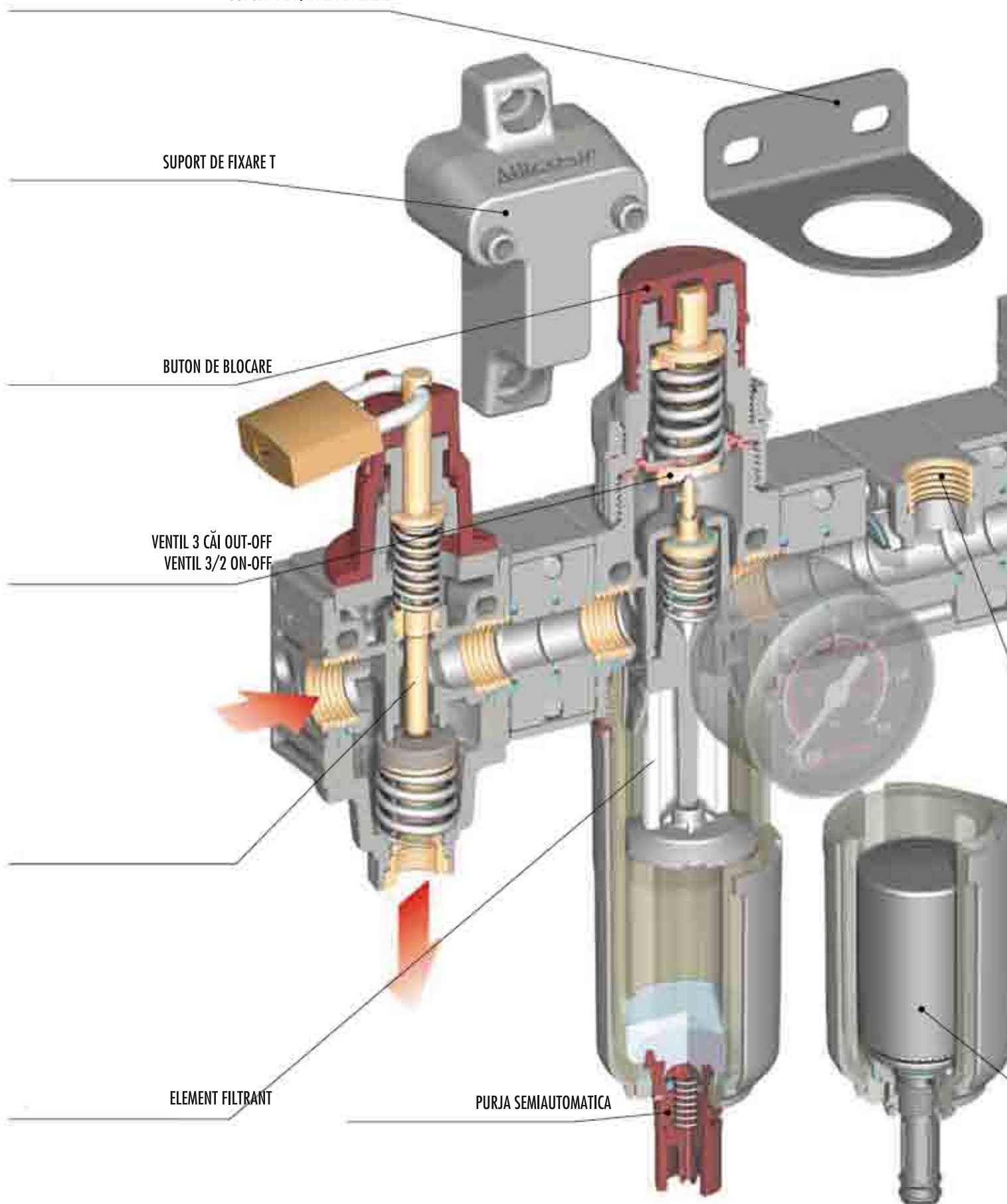

SERIA MODULARA 042, 1/4"

V3+FR+PA+SV+AVP+L

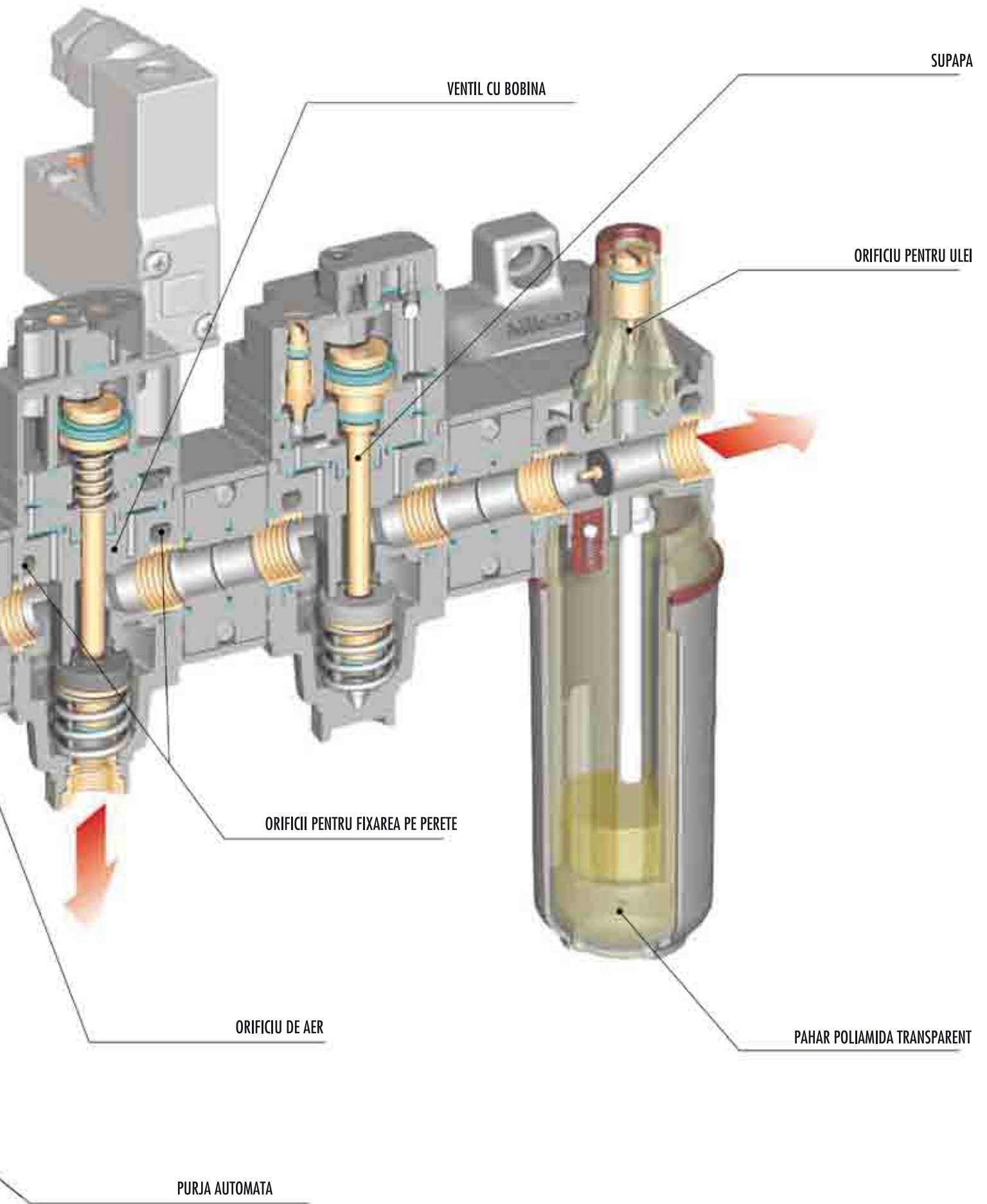

REGULATOARE DE AER

SERIA 042 1/4

REGULATOR

COD	REFERINTE
TH042.01.00004	R 1/4" 042 04 R
TH042.01.*****	R 1/4" 042 08 R
TH042.01.00006	R 1/4" 042 12 R



REGULATOR + MANOMETRU

COD	REFERINTE
TH042.01.M0004	R 1/4" 042 04 R + MANOMETRU
TH042.01.M*****	R 1/4" 042 08 R + MANOMETRU
TH042.01.M0006	R 1/4" 042 12 R + MANOMETRU



REGULATOR PENTRU BATERIE

COD	REFERINTE
TH042.01.00045	R 1/4"042 02 R B (baterie)
TH042.01.00046	R 1/4"042 04 R B (baterie)
TH042.01.00047	R 1/4"042 08 R B (baterie)
TH042.01.00048	R 1/4"042 12 R B (baterie)



MICROFILTRU

COD	REFERINTE
TH042.02.00064	MF 1/4" 042 0,01 TT SS
TH042.02.00115	MF 1/4" 042 0,01 PE SS
TH042.02.00111	MF 1/4" 042 0,1 TC SS (pahar mic)
PURJARE AUTOMATA	
TH042.02.00159	MF 1/4" 042 0,01 TT SA
TH042.02.00160	MF 1/4" 042 0,01 PE SA
Diferential purjare automata	
TH042.02.00684	MF 1/4" 042 0,01 TT SAD
TH042.02.00685	MF 1/4" 042 0,01 PE SAD



FILTRU

COD	REFERINTE
TH042.02.*****	F 1/4" 042 20 TT SS
TH042.02.00109	F 1/4" 042 5 TT SS
TH042.02.00072	F 1/4" 042 20 PE SS
TH042.02.00118	F 1/4" 042 5 PE SS
TH042.02.00110	F 1/4" 042 20 TC SS (pahar mic)
TH042.02.00176	F 1/4" 042 5 TC SS (pahar mic)
purjare automata	
TH042.02.00151	F 1/4" 042 20 TT SA
TH042.02.00152	F 1/4" 042 5 TT SA
TH042.02.00153	F 1/4" 042 20 PE SA
TH042.02.00154	F 1/4" 042 5 PE SA
Diferential purjare automata	
TH042.02.00180	F 1/4" 042 20 TT SAD
TH042.02.00181	F 1/4" 042 5 TT SAD
TH042.02.00182	F 1/4" 042 20 PE SAD
TH042.02.00183	F 1/4" 042 5 PE SAD



FILTRU REGULATOR

COD	REFERINTE
TH042.04.00022	FR 1/4" 042 20 04 R TT SS
TH042.04.*****	FR 1/4" 042 20 08 R TT SS
TH042.04.00052	FR 1/4" 042 20 12 R TT SS
TH042.04.00112	FR 1/4" 042 5 04 R TT SS
TH042.04.00113	FR 1/4" 042 5 08 R TT SS
TH042.04.00114	FR 1/4" 042 5 12 R TT SS
TH042.04.00126	FR 1/4" 042 20 04 R PE SS
TH042.04.00072	FR 1/4" 042 20 08 R PE SS
TH042.04.00127	FR 1/4" 042 20 12 R PE SS
TH042.04.00128	FR 1/4" 042 5 04 R PE SS
TH042.04.00129	FR 1/4" 042 5 08 R PE SS
TH042.04.00130	FR 1/4" 042 5 12 R PE SS
TH042.04.00133	FR 1/4" 042 20 08 R TC SS (pahar mic)
TH042.04.00229	FR 1/4" 042 20 12 R TC SS (pahar mic)
TH042.04.00230	FR 1/4" 042 5 08 R TC SS (pahar mic)
TH042.04.00251	FR 1/4" 042 5 12 R TC SS (pahar mic)
Purjare automata	
TH042.04.00152	FR 1/4" 042 20 04 R TT SA
TH042.04.00151	FR 1/4" 042 20 08 R TT SA
TH042.04.00153	FR 1/4" 042 20 12 R TT SA
TH042.04.00155	FR 1/4" 042 5 04 R TT SA
TH042.04.00154	FR 1/4" 042 5 08 R TT SA
TH042.04.00156	FR 1/4" 042 5 12 R TT SA
TH042.04.00158	FR 1/4" 042 20 04 R PE SA
TH042.04.00157	FR 1/4" 042 20 08 R PE SA
TH042.04.00159	FR 1/4" 042 20 12 R PE SA
TH042.04.00161	FR 1/4" 042 5 04 R PE SA
TH042.04.00160	FR 1/4" 042 5 08 R PE SA
TH042.04.00162	FR 1/4" 042 5 12 R PE SA
Diferential purjare automata	
TH042.04.00238	FR 1/4" 042 20 08 R TT SAD
TH042.04.00239	FR 1/4" 042 20 12 R TT SAD
TH042.04.00240	FR 1/4" 042 5 08 R TT SAD
TH042.04.00241	FR 1/4" 042 5 12 R TT SAD
TH042.04.00242	FR 1/4" 042 20 08 R PE SAD
TH042.04.00243	FR 1/4" 042 20 12 R PE SAD
TH042.04.00244	FR 1/4" 042 5 08 R PE SAD
TH042.04.00245	FR 1/4" 042 5 12 R PE SAD



UNGATOR

COD	REFERINTE
TH042.03.*****	L 1/4" 042 TT
TH042.03.00072	L 1/4" 042 PE
TH042.03.00078	L 1/4" 042 TC (pahar mic)
TH042.03.00500	L 1/4" 042 TT VL
TH042.03.00501	L 1/4" 042 PE VL



REGULATOARE DE AER

SERIA 042 1/4

FILTRU REGULATOR + MANOMETRU

COD	REFERINTE
THO42.04.M0022	FR 1/4" 042 20 04 R TT SS + MANOMETRU
THO42.04.M****	FR 1/4" 042 20 08 R TT SS + MANOMETRU
THO42.04.M0052	FR 1/4" 042 20 12 R TT SS + MANOMETRU
THO42.04.M0112	FR 1/4" 042 5 04 R TT SS + MANOMETRU
THO42.04.M0113	FR 1/4" 042 5 08 R TT SS + MANOMETRU
THO42.04.M0114	FR 1/4" 042 5 12 R TT SS + MANOMETRU
THO42.04.M0126	FR 1/4" 042 20 04 R PE SS + MANOMETRU
THO42.04.M0072	FR 1/4" 042 20 08 R PE SS + MANOMETRU
THO42.04.M0127	FR 1/4" 042 20 12 R PE SS + MANOMETRU
THO42.04.M0128	FR 1/4" 042 5 04 R PE SS + MANOMETRU
THO42.04.M0129	FR 1/4" 042 5 08 R PE SS + MANOMETRU
THO42.04.M0130	FR 1/4" 042 5 12 R PE SS + MANOMETRU

ROBINET CU TREI IESIRI

COD	REFERINTE
THO42.25.00001	V 1/4" 042 V3

ROBINET DE INCHIDERE

COD	REFERINTE
THO42.26.00002	SV 1/4" 042 Pred. C. Electr. Microsol/Pneum.
THC50.26.00002	Kit. C. Electr. 3/2 NC 2W 24V CC Microsol
THC50.26.00003	Kit. C. Electr. 3/2 NC 1W 24V AC Microsol
THC50.26.00004	Kit. C. Electr. 3/2 NC 1W 110V AC Microsol
THC50.26.00005	Kit. C. Electr. 3/2 NC 1W 220V AC Microsol
THC40.26.00014	Kit. C. Pneumatic SV
THO42.26.00001	SV 1/4" 042 Pred. C. Electr. Cnomo
THC40.26.00011	C. Electr. EV 3/2 NC Cnomo
THA50.26.00018	Bobina DC 12V Sp.=22 mm
THA50.26.00006	Bobina DC 24V Sp.=22 mm
THA50.26.00007	BobinaAC 24V Sp.=22 mm
THA50.26.00008	Bobina AC 110V Sp.=22 mm
THA50.26.00009	Bobina AC 220V Sp.=22 mm
THA50.26.00010	Conector 22 mm

F+R+L UNITE + MANOMETRU

COD	REFERINTE
THO42.05.M0111	F+R+L 1/4" 042 20 04 R TT SS + MANOMETRU
THO42.05.M****	F+R+L 1/4" 042 20 08 R TT SS + MANOMETRU
THO42.05.M0103	F+R+L 1/4" 042 20 12 R TT SS + MANOMETRU
THO42.05.M0104	F+R+L 1/4" 042 5 04 R TT SS + MANOMETRU
THO42.05.M0105	F+R+L 1/4" 042 5 08 R TT SS + MANOMETRU
THO42.05.M0106	F+R+L 1/4" 042 5 12 R TT SS + MANOMETRU
THO42.05.M0113	F+R+L 1/4" 042 20 04 R PE SS + MANOMETRU
THO42.05.M0118	F+R+L 1/4" 042 20 08 R PE SS + MANOMETRU
THO42.05.M0114	F+R+L 1/4" 042 20 12 R PE SS + MANOMETRU
THO42.05.M0115	F+R+L 1/4" 042 5 04 R PE SS + MANOMETRU
THO42.05.M0116	F+R+L 1/4" 042 5 08 R PE SS + MANOMETRU
THO42.05.M0117	F+R+L 1/4" 042 5 12 R PE SS + MANOMETRU

ROBINET CU SLOW START

COD	REFERINTE
THO42.27.00001	AVP 1/4" 042 PN Autom.

REGULATOARE DE AER

SERIA 042 1/4

F+R+L UNITE

COD	REFERINTE
TH042.05.00111	F+R+L 1/4" 042 20 04 R TT SS
TH042.05.*****	F+R+L 1/4" 042 20 08 R TT SS
TH042.05.00103	F+R+L 1/4" 042 20 12 R TT SS
TH042.05.00104	F+R+L 1/4" 042 5 04 R TT SS
TH042.05.00105	F+R+L 1/4" 042 5 08 R TT SS
TH042.05.00106	F+R+L 1/4" 042 5 12 R TT SS
TH042.05.00500	F+R+L 1/4" 042 20 08 R TT SS VL
TH042.05.00504	F+R+L 1/4" 042 20 12 R TT SS VL
TH042.05.00506	F+R+L 1/4" 042 5 08 R TT SS VL
TH042.05.00508	F+R+L 1/4" 042 5 12 R TT SS VL
TH042.05.00113	F+R+L 1/4" 042 20 04 R PE SS
TH042.05.00118	F+R+L 1/4" 042 20 08 R PE SS
TH042.05.00114	F+R+L 1/4" 042 20 12 R PE SS
TH042.05.00115	F+R+L 1/4" 042 5 04 R PE SS
TH042.05.00116	F+R+L 1/4" 042 5 08 R PE SS
TH042.05.00117	F+R+L 1/4" 042 5 12 R PE SS
TH042.05.00501	F+R+L 1/4" 042 20 08 R PE SS VL
TH042.05.00505	F+R+L 1/4" 042 20 12 R PE SS VL
TH042.05.00507	F+R+L 1/4" 042 5 08 R PE SS VL
TH042.05.00509	F+R+L 1/4" 042 5 12 R PE SS VL
TH042.05.00171	F+R+L 1/4" 042 20 08 R TC SS (pahar mic)
TH042.05.00172	F+R+L 1/4" 042 20 12 R TC SS (pahar mic)
TH042.05.00173	F+R+L 1/4" 042 5 08 R TC SS (pahar mic)
TH042.05.00174	F+R+L 1/4" 042 5 12 R TC SS (pahar mic)
Purjare automata	
TH042.05.00152	F+R+L 1/4" 042 20 04 R TT SA
TH042.05.00151	F+R+L 1/4" 042 20 08 R TT SA
TH042.05.00153	F+R+L 1/4" 042 20 12 R TT SA
TH042.05.00155	F+R+L 1/4" 042 5 04 R TT SA
TH042.05.00154	F+R+L 1/4" 042 5 08 R TT SA
TH042.05.00156	F+R+L 1/4" 042 5 12 R TT SA
TH042.05.00510	F+R+L 1/4" 042 20 08 R TT SA VL
TH042.05.00512	F+R+L 1/4" 042 20 12 R TT SA VL
TH042.05.00514	F+R+L 1/4" 042 5 08 R TT SA VL
TH042.05.00517	F+R+L 1/4" 042 5 12 R TT SA VL
TH042.05.00158	F+R+L 1/4" 042 20 04 R PE SA
TH042.05.00157	F+R+L 1/4" 042 20 08 R PE SA
TH042.05.00159	F+R+L 1/4" 042 20 12 R PE SA
TH042.05.00161	F+R+L 1/4" 042 5 04 R PE SA
TH042.05.00160	F+R+L 1/4" 042 5 08 R PE SA
TH042.05.00162	F+R+L 1/4" 042 5 12 R PE SA
TH042.05.00511	F+R+L 1/4" 042 20 08 R PE SA VL
TH042.05.00513	F+R+L 1/4" 042 20 12 R PE SA VL
TH042.05.00515	F+R+L 1/4" 042 5 08 R PE SA VL
TH042.05.00518	F+R+L 1/4" 042 5 12 R PE SA VL
Diferential purjare automata	
TH042.05.00166	F+R+L 1/4" 042 20 08 R TT SAD
TH042.05.00167	F+R+L 1/4" 042 20 12 R TT SAD
TH042.05.00168	F+R+L 1/4" 042 20 08 R PE SAD
TH042.05.00169	F+R+L 1/4" 042 20 12 R PE SAD



FR+L UNITE

COD	REFERINTE
TH042.06.00113	FR+L 1/4" 042 20 04 R TT SS
TH042.06.*****	FR+L 1/4" 042 20 08 R TT SS
TH042.06.00052	FR+L 1/4" 042 20 12 R TT SS
TH042.06.00114	FR+L 1/4" 042 5 04 R TT SS
TH042.06.00115	FR+L 1/4" 042 5 08 R TT SS
TH042.06.00116	FR+L 1/4" 042 5 12 R TT SS
TH042.06.00500	FR+L 1/4" 042 20 08 R TT SS VL
TH042.06.00504	FR+L 1/4" 042 20 12 R TT SS VL
TH042.06.00506	FR+L 1/4" 042 5 08 R TT SS VL
TH042.06.00508	FR+L 1/4" 042 5 12 R TT SS VL
TH042.06.00125	FR+L 1/4" 042 20 04 R PE SS
TH042.06.00072	FR+L 1/4" 042 20 08 R PE SS
TH042.06.00126	FR+L 1/4" 042 20 12 R PE SS
TH042.06.00127	FR+L 1/4" 042 5 04 R PE SS
TH042.06.00128	FR+L 1/4" 042 5 08 R PE SS
TH042.06.00129	FR+L 1/4" 042 5 12 R PE SS
TH042.06.00124	FR+L 1/4" 042 20 08 R TC SS (pahar mic)
TH042.06.00132	FR+L 1/4" 042 20 12 R TC SS (pahar mic)
TH042.06.00133	FR+L 1/4" 042 5 08 R TC SS (pahar mic)
TH042.06.00134	FR+L 1/4" 042 5 12 R TC SS (pahar mic)
TH042.06.00501	FR+L 1/4" 042 20 08 R PE SS VL
TH042.06.00505	FR+L 1/4" 042 20 12 R PE SS VL
TH042.06.00507	FR+L 1/4" 042 5 08 R PE SS VL
TH042.06.00509	FR+L 1/4" 042 5 12 R PE SS VL
Purjare automata	
TH042.06.00152	FR+L 1/4" 042 20 04 R TT SA
TH042.06.00151	FR+L 1/4" 042 20 08 R TT SA
TH042.06.00153	FR+L 1/4" 042 20 12 R TT SA
TH042.06.00155	FR+L 1/4" 042 5 04 R TT SA
TH042.06.00154	FR+L 1/4" 042 5 08 R TT SA
TH042.06.00156	FR+L 1/4" 042 5 12 R TT SA
TH042.06.00510	FR+L 1/4" 042 20 08 R TT SA VL
TH042.06.00512	FR+L 1/4" 042 20 12 R TT SA VL
TH042.06.00514	FR+L 1/4" 042 5 08 R TT SA VL
TH042.06.00517	FR+L 1/4" 042 5 12 R TT SA VL
TH042.06.00158	FR+L 1/4" 042 20 04 R PE SA
TH042.06.00157	FR+L 1/4" 042 20 08 R PE SA
TH042.06.00159	FR+L 1/4" 042 20 12 R PE SA
TH042.06.00161	FR+L 1/4" 042 5 04 R PE SA
TH042.06.00160	FR+L 1/4" 042 5 08 R PE SA
TH042.06.00162	FR+L 1/4" 042 5 12 R PE SA
TH042.06.00511	FR+L 1/4" 042 20 08 R PE SA VL
TH042.06.00513	FR+L 1/4" 042 20 12 R PE SA VL
TH042.06.00515	FR+L 1/4" 042 5 08 R PE SA VL
TH042.06.00518	FR+L 1/4" 042 5 12 R PE SA VL
Diferential purjare automata	
TH042.06.00191	FR+L 1/4" 042 20 08 R TT SAD
TH042.06.00192	FR+L 1/4" 042 20 12 R TT SAD
TH042.06.00193	FR+L 1/4" 042 20 08 R PE SAD
TH042.06.00194	FR+L 1/4" 042 20 12 R PE SAD



FR+L UNITE



COD	REFERINTE
TH042.06.00113	FR+L 1/4" 042 20 04 R TT SS
TH042.06.*****	FR+L 1/4" 042 20 08 R TT SS
TH042.06.00052	FR+L 1/4" 042 20 12 R TT SS
TH042.06.00114	FR+L 1/4" 042 5 04 R TT SS
TH042.06.00115	FR+L 1/4" 042 5 08 R TT SS
TH042.06.00116	FR+L 1/4" 042 5 12 R TT SS
TH042.06.00500	FR+L 1/4" 042 20 08 R TT SS VL
TH042.06.00504	FR+L 1/4" 042 20 12 R TT SS VL
TH042.06.00506	FR+L 1/4" 042 5 08 R TT SS VL
TH042.06.00508	FR+L 1/4" 042 5 12 R TT SS VL
TH042.06.00125	FR+L 1/4" 042 20 04 R PE SS
TH042.06.00072	FR+L 1/4" 042 20 08 R PE SS
TH042.06.00126	FR+L 1/4" 042 20 12 R PE SS
TH042.06.00127	FR+L 1/4" 042 5 04 R PE SS
TH042.06.00128	FR+L 1/4" 042 5 08 R PE SS
TH042.06.00129	FR+L 1/4" 042 5 12 R PE SS
TH042.06.00124	FR+L 1/4" 042 20 08 R TC SS (pahar mic)
TH042.06.00132	FR+L 1/4" 042 20 12 R TC SS (pahar mic)
TH042.06.00133	FR+L 1/4" 042 5 08 R TC SS (pahar mic)
TH042.06.00134	FR+L 1/4" 042 5 12 R TC SS (pahar mic)
TH042.06.00501	FR+L 1/4" 042 20 08 R PE SS VL
TH042.06.00505	FR+L 1/4" 042 20 12 R PE SS VL
TH042.06.00507	FR+L 1/4" 042 5 08 R PE SS VL
TH042.06.00509	FR+L 1/4" 042 5 12 R PE SS VL
Purjare automata	
TH042.06.00152	FR+L 1/4" 042 20 04 R TT SA
TH042.06.00151	FR+L 1/4" 042 20 08 R TT SA
TH042.06.00153	FR+L 1/4" 042 20 12 R TT SA
TH042.06.00155	FR+L 1/4" 042 5 04 R TT SA
TH042.06.00154	FR+L 1/4" 042 5 08 R TT SA
TH042.06.00156	FR+L 1/4" 042 5 12 R TT SA
TH042.06.00510	FR+L 1/4" 042 20 08 R TT SA VL
TH042.06.00512	FR+L 1/4" 042 20 12 R TT SA VL
TH042.06.00514	FR+L 1/4" 042 5 08 R TT SA VL
TH042.06.00517	FR+L 1/4" 042 5 12 R TT SA VL
TH042.06.00158	FR+L 1/4" 042 20 04 R PE SA
TH042.06.00157	FR+L 1/4" 042 20 08 R PE SA
TH042.06.00159	FR+L 1/4" 042 20 12 R PE SA
TH042.06.00161	FR+L 1/4" 042 5 04 R PE SA
TH042.06.00160	FR+L 1/4" 042 5 08 R PE SA
TH042.06.00162	FR+L 1/4" 042 5 12 R PE SA
TH042.06.00511	FR+L 1/4" 042 20 08 R PE SA VL
TH042.06.00513	FR+L 1/4" 042 20 12 R PE SA VL
TH042.06.00515	FR+L 1/4" 042 5 08 R PE SA VL
TH042.06.00518	FR+L 1/4" 042 5 12 R PE SA VL
Diferential purjare automata	
TH042.06.00191	FR+L 1/4" 042 20 08 R TT SAD
TH042.06.00192	FR+L 1/4" 042 20 12 R TT SAD
TH042.06.00193	FR+L 1/4" 042 20 08 R PE SAD
TH042.06.00194	FR+L 1/4" 042 20 12 R PE SAD

V3+FR+L UNITE



COD	REFERINTE
TH042.36.00113	V3+FR+L 1/4" 042 20 04 R TT SS
TH042.36.*****	V3+FR+L 1/4" 042 20 08 R TT SS
TH042.36.00052	V3+FR+L 1/4" 042 20 12 R TT SS
TH042.36.00114	V3+FR+L 1/4" 042 5 04 R TT SS
TH042.36.00115	V3+FR+L 1/4" 042 5 08 R TT SS
TH042.36.00116	V3+FR+L 1/4" 042 5 12 R TT SS
TH042.36.00500	V3+FR+L 1/4" 042 20 08 R TT SS VL
TH042.36.00504	V3+FR+L 1/4" 042 20 12 R TT SS VL
TH042.36.00506	V3+FR+L 1/4" 042 5 08 R TT SS VL
TH042.36.00508	V3+FR+L 1/4" 042 5 12 R TT SS VL
TH042.36.00130	V3+FR+L 1/4" 042 20 08 R TC SS (pahar mic)
TH042.36.00131	V3+FR+L 1/4" 042 20 12 R TC SS (pahar mic)
TH042.36.00132	V3+FR+L 1/4" 042 5 08 R TC SS (pahar mic)
TH042.36.00133	V3+FR+L 1/4" 042 5 12 R TC SS (pahar mic)
TH042.36.00125	V3+FR+L 1/4" 042 20 04 R PE SS
TH042.36.00072	V3+FR+L 1/4" 042 20 08 R PE SS
TH042.36.00126	V3+FR+L 1/4" 042 20 12 R PE SS
TH042.36.00127	V3+FR+L 1/4" 042 5 04 R PE SS
TH042.36.00128	V3+FR+L 1/4" 042 5 08 R PE SS
TH042.36.00129	V3+FR+L 1/4" 042 5 12 R PE SS
TH042.36.00501	V3+FR+L 1/4" 042 20 08 R PE SS VL
TH042.36.00505	V3+FR+L 1/4" 042 20 12 R PE SS VL
TH042.36.00507	V3+FR+L 1/4" 042 5 08 R PE SS VL
TH042.36.00509	V3+FR+L 1/4" 042 5 12 R PE SS VL
Purjare automata	
TH042.36.00152	V3+FR+L 1/4" 042 20 04 R TT SA
TH042.36.00151	V3+FR+L 1/4" 042 20 08 R TT SA
TH042.36.00153	V3+FR+L 1/4" 042 20 12 R TT SA
TH042.36.00155	V3+FR+L 1/4" 042 5 04 R TT SA
TH042.36.00154	V3+FR+L 1/4" 042 5 08 R TT SA
TH042.36.00156	V3+FR+L 1/4" 042 5 12 R TT SA
TH042.36.00510	V3+FR+L 1/4" 042 20 08 R TT SA VL
TH042.36.00512	V3+FR+L 1/4" 042 20 12 R TT SA VL
TH042.36.00514	V3+FR+L 1/4" 042 5 08 R TT SA VL
TH042.36.00517	V3+FR+L 1/4" 042 5 12 R TT SA VL
TH042.36.00158	V3+FR+L 1/4" 042 20 04 R PE SA
TH042.36.00157	V3+FR+L 1/4" 042 20 08 R PE SA
TH042.36.00159	V3+FR+L 1/4" 042 20 12 R PE SA
TH042.36.00161	V3+FR+L 1/4" 042 5 04 R PE SA
TH042.36.00160	V3+FR+L 1/4" 042 5 08 R PE SA
TH042.36.00162	V3+FR+L 1/4" 042 5 12 R PE SA
TH042.36.00511	V3+FR+L 1/4" 042 20 08 R PE SA VL
TH042.36.00513	V3+FR+L 1/4" 042 20 12 R PE SA VL
TH042.36.00515	V3+FR+L 1/4" 042 5 08 R PE SA VL
TH042.36.00518	V3+FR+L 1/4" 042 5 12 R PE SA VL
Diferential purjare automata	
TH042.36.00191	V3+FR+L 1/4" 042 20 08 R TT SAD
TH042.36.00192	V3+FR+L 1/4" 042 20 12 R TT SAD
TH042.36.00193	V3+FR+L 1/4" 042 20 08 R PE SAD
TH042.36.00194	V3+FR+L 1/4" 042 20 12 R PE SAD

REGULATOARE DE AER

SERIA 042 1/4

FR+L UNITE + MANOMETRU

COD	REFERINTE
TH042.06.M0113	FR+L 1/4" 042 20 04 R TT SS+MANOMETRU
TH042.06.M****	FR+L 1/4" 042 20 08 R TT SS+MANOMETRU
TH042.06.M0052	FR+L 1/4" 042 20 12 R TT SS+MANOMETRU
TH042.06.M0114	FR+L 1/4" 042 5 04 R TT SS+MANOMETRU
TH042.06.M0115	FR+L 1/4" 042 5 08 R TT SS+MANOMETRU
TH042.06.M0116	FR+L 1/4" 042 5 12 R TT SS+MANOMETRU
TH042.06.M0125	FR+L 1/4" 042 20 04 R PE SS+MANOMETRU
TH042.06.M0072	FR+L 1/4" 042 20 08 R PE SS+MANOMETRU
TH042.06.M0126	FR+L 1/4" 042 20 12 R PE SS+MANOMETRU
TH042.06.M0127	FR+L 1/4" 042 5 04 R PE SS+MANOMETRU
TH042.06.M0128	FR+L 1/4" 042 5 08 R PE SS+MANOMETRU
TH042.06.M0129	FR+L 1/4" 042 5 12 R PE SS+MANOMETRU



V3+FR+L UNITE + MANOMETRU

COD	REFERINTE
TH042.36.M0113	V3+FR+L 1/4" 042 20 04 R TT SS+MANOMETRU
TH042.36.M****	V3+FR+L 1/4" 042 20 08 R TT SS+MANOMETRU
TH042.36.M0052	V3+FR+L 1/4" 042 20 12 R TT SS+MANOMETRU
TH042.36.M0114	V3+FR+L 1/4" 042 5 04 R TT SS+MANOMETRU
TH042.36.M0115	V3+FR+L 1/4" 042 5 08 R TT SS+MANOMETRU
TH042.36.M0116	V3+FR+L 1/4" 042 5 12 R TT SS+MANOMETRU
TH042.36.M0125	V3+FR+L 1/4" 042 20 04 R PE SS+MANOMETRU
TH042.36.M0072	V3+FR+L 1/4" 042 20 08 R PE SS+MANOMETRU
TH042.36.M0126	V3+FR+L 1/4" 042 20 12 R PE SS+MANOMETRU
TH042.36.M0127	V3+FR+L 1/4" 042 5 04 R PE SS+MANOMETRU
TH042.36.M0128	V3+FR+L 1/4" 042 5 08 R PE SS+MANOMETRU
TH042.36.M0129	V3+FR+L 1/4" 042 5 12 R PE SS+MANOMETRU



F+MF UNITE

COD	REFERINTE
TH042.09.00001	F 1/4" 042 5 TT SS+MF 1/4" 0,01 TT SS
TH042.09.00003	F 1/4" 042 5 PE SS+MF 1/4" 0,01 PE SS
TH042.09.00005	F 1/4" 042 5 TC SS+MF 1/4" 0,1 TC SS (pahar mic)
Purjare automata	
TH042.09.00002	F 1/4" 042 5 TT SS+MF 1/4" 0,01 TT SA
TH042.09.00004	F 1/4" 042 5 PE SS+MF 1/4" 0,01 PE SA
Diferential purjare automata	
TH042.09.00005	F 1/4" 042 5 TT SS+MF 1/4" 0,01 TT SAD
TH042.09.00006	F 1/4" 042 5 PE SS+MF 1/4" 0,01 PE SAD



F+L UNITE

COD	REFERINTE
TH042.07.****	F+L 1/4" 042 20 TT SS
TH042.07.00112	F+L 1/4" 042 5 TT SS
TH042.07.00132	F+L 1/4" 042 20 TC SS (pahar mic)
TH042.07.00133	F+L 1/4" 042 5 TC SS (pahar mic)
TH042.07.00500	F+L 1/4" 042 20 TT SS VL
TH042.07.00506	F+L 1/4" 042 5 TT SS VL
TH042.07.00072	F+L 1/4" 042 20 PE SS
TH042.07.00115	F+L 1/4" 042 5 PE SS
TH042.07.00501	F+L 1/4" 042 20 PE SS VL
TH042.07.00507	F+L 1/4" 042 5 PE SS VL
Purjare automata	
TH042.07.00151	F+L 1/4" 042 20 TT SA
TH042.07.00152	F+L 1/4" 042 5 TT SA
TH042.07.00510	F+L 1/4" 042 20 TT SA VL
TH042.07.00514	F+L 1/4" 042 5 TT SA VL
TH042.07.00153	F+L 1/4" 042 20 PE SA
TH042.07.00154	F+L 1/4" 042 5 PE SA
TH042.07.00513	F+L 1/4" 042 20 PE SA VL
TH042.07.00515	F+L 1/4" 042 5 PE SA VL
Diferential purjare automata	
TH042.07.00128	F+L 1/4" 042 20 TT SAD
TH042.07.00129	F+L 1/4" 042 5 TT SAD
TH042.07.00130	F+L 1/4" 042 20 PE SAD
TH042.07.00131	F+L 1/4" 042 5 PE SAD



ACCESORII SERIA 042 1/4

MANOMETRU

COD	REFERINTE
THA38.00.00114	MANOMETRU 1/8 D=40 scala 0-2,5 bar
THA38.00.00055	MANOMETRU 1/8 D= 40 scala 0-6 bar
THA38.00.00026	MANOMETRU 1/8 D= 40 scala 0-12 bar



SUPORT

COD	REFERINTE
THC38.00.000069	Suport
THC42.05.00001	Suport pentru perete - universal



DOP

COD	REFERINTE
THB38.00.00018	Tehnopolimer 1/8 dop



REGULATOARE DE AER 050 3/8" - 052 1/2"

GHID DE REFERINTE

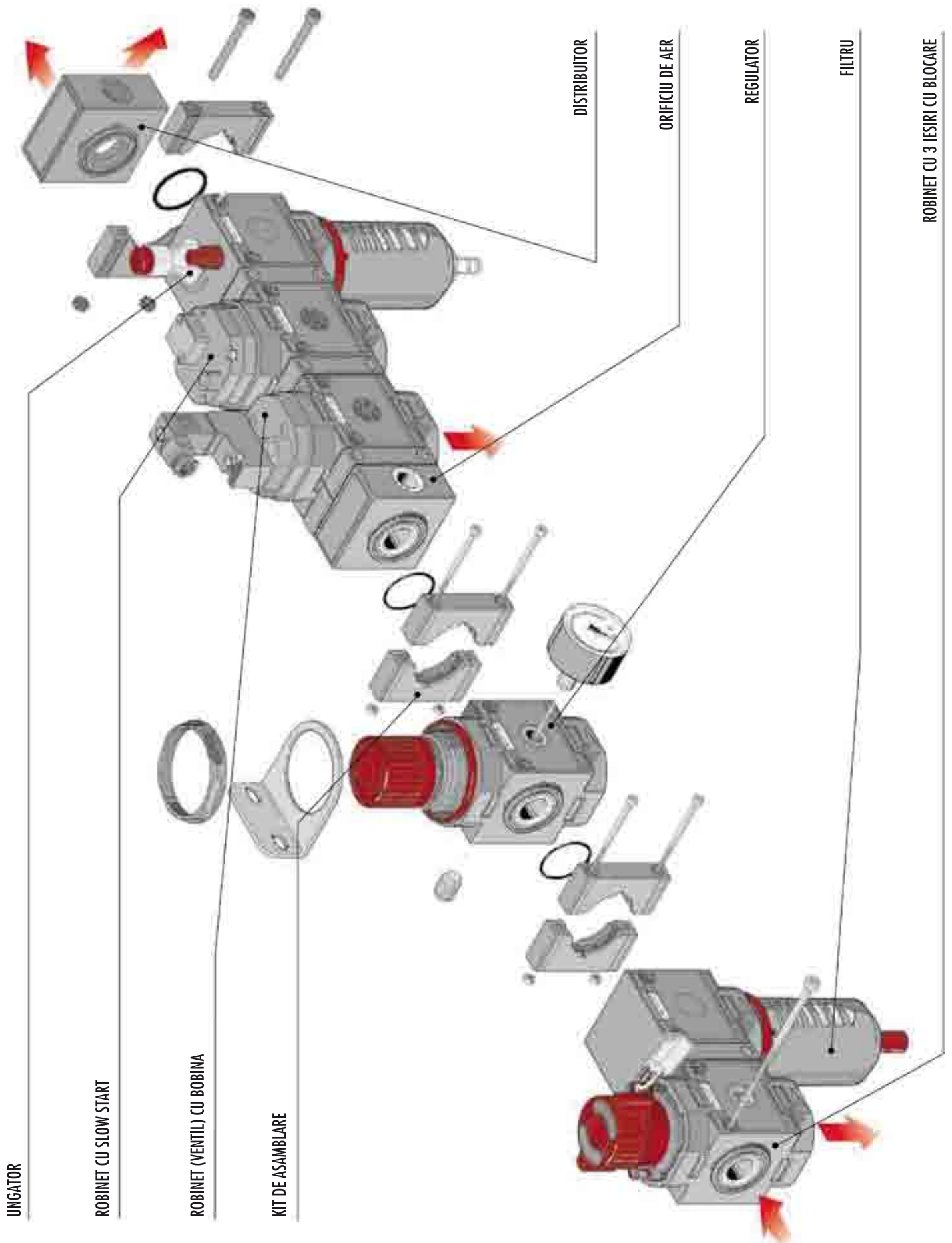

REGULATOR DE AER 050 3/8" - 052 1/2"

GHID DE REFERINTE

FR	3/8"	050	20	08	R	PE	SS	—
PRODUS R - REGULATOR F - FILTRU MF - MICROFILTRU L - UNGATOR FR - FILTRU REGULATOR V3 - VENTIL - 3 CAI SU - VENTIL DE INCHIDERE AVP - VENTIL CU START LENT								TIPURI SPECIALE INCARCARE CU VID - VL INDICATOR DE NIVEL- LI
CONEXIUNI 3/8" = G3/8" 1/2" = G1/2"								PURJARE MANUAL SEMI-AUTOMAT - SS AUTOMATA- SA AUTOMATA DIFERENTIAL - SAD
SERIA 050 052								PAHAR PROTECTIE PE EXTERIOR - PE
ELEMENT DE FILTRARE 5 = 5 microni 20 = 20 microni 0,1 = 0,1 microni								VARIANTA PENTRU AER - R PENTRU APA - A
								DOMENIU DE PRESIUNE 0÷4 Bari = 04 0÷8 Bari = 08 0÷12 Bari = 12

ACCESORII

SERIA 042 1/4

PURJARE AUTOMATA "SA"



COD	REFERINTE
THC40.02.00130	Purjare automata
THC40.02.00131	kit SA / SAD

PURJARE AUTOMATA "SAD"



COD	REFERINTE
THC42.02.00012	Diferential purjare automata
THC40.02.00131	kit SA / SAD

DISTRIBUITOR 2/2



COD	REFERINTE
THC40.05.00103	Distribuitor 2/2(1/4 1/8)
THC42.05.00003	Distribuitor 3/2(1/8 1/8 1/4)

DISTRIBUITOR

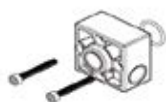

COD	REFERINTE
THC42.06.00002	Distribuitor cu o intrare 1/4
THC42.06.00003	Distribuitor cu o iesire 1/4

KIT



COD	REFERINTE
THC40.05.00001	F+R+L-V3+FR+L UNITE
THC40.06.00001	FR+L-V3+FR UNITE ANSAMBLU KIT
THC40.07.00001	F+MF-F+L UNITE ANSAMBLU KIT
THC42.06.00001	042 BATERIE ANSAMBLU KIT

REGULATOARE DE AER

SERIA 050 3/8

REGULATOR



COD	REFERINTE
TH050.11.00004	R 3/8" 050 04 R
TH050.11.*****	R 3/8" 050 08 R
TH050.11.00001	R 3/8" 050 12 R

REGULATOR + MANOMETRU



COD	REFERINTE
TH050.11.M0004	R 3/8" 050 04 R + MANOMETRU
TH050.11.M*****	R 3/8" 050 08 R + MANOMETRU
TH050.11.M0001	R 3/8" 050 12 R + MANOMETRU

FILTRU



COD	REFERINTE
TH050.12.00025	F 3/8" 050 20 PE SS
TH050.12.00028	F 3/8" 050 5 PE SS
Purjare automata	
TH050.12.00053	F 3/8" 050 20 PE SA
TH050.12.00054	F 3/8" 050 5 PE SA
Diferential purjare automata	
TH050.12.00070	F 3/8" 050 20 PE SAD
TH050.12.00071	F 3/8" 050 5 PE SAD

MICROFILTRU



COD	REFERINTE
TH050.12.00010	MF 3/8" 050 0,01 PE SS
Purjare automata	
TH050.12.00060	MF 3/8" 050 0,01 PE SA
Diferential purjare automata	
TH050.12.00072	MF 3/8" 050 0,01 PE SAD

UNGATOR



COD	REFERINTE
TH050.13.00025	L 3/8" 050 PE
TH050.13.00500	L 3/8" 050 PE VL
TH050.13.00034	L 3/8" 050 PE IL

ROBINET CU TREI IESIRI



COD	REFERINTE
TH050.25.00001	V3/8" 050 V3

REGULATOR DE AER

SERIA 050 3/8

FILTRU REGULATOR



COD	REFERINTE
TH050.14.00036	FR 3/8" 050 20 04 R PE SS
TH050.14.00025	FR 3/8" 050 20 08 R PE SS
TH050.14.00001	FR 3/8" 050 20 12 R PE SS
TH050.14.00037	FR 3/8" 050 5 04 R PE SS
TH050.14.00038	FR 3/8" 050 5 08 R PE SS
TH050.14.00039	FR 3/8" 050 5 12 R PE SS
Purjare automata	
TH050.14.00058	FR 3/8" 050 20 04 R PE SA
TH050.14.00057	FR 3/8" 050 20 08 R PE SA
TH050.14.00059	FR 3/8" 050 20 12 R PE SA
TH050.14.00061	FR 3/8" 050 5 04 R PE SA
TH050.14.00060	FR 3/8" 050 5 08 R PE SA
TH050.14.00062	FR 3/8" 050 5 12 R PE SA
Diferential purjare automata	
TH050.14.00070	FR 3/8" 050 20 08 R PE SAD
TH050.14.00071	FR 3/8" 050 20 12 R PE SAD
TH050.14.00072	FR 3/8" 050 5 08 R PE SAD
TH050.14.00073	FR 3/8" 050 5 12 R PE SAD

FILTRU REGULATOR + MANOMETRU



COD	REFERINTE
TH050.14.M0036	FR 3/8" 050 20 04 R PE SS +MANOMETRU
TH050.14.M0025	FR 3/8" 050 20 08 R PE SS +MANOMETRU
TH050.14.M0001	FR 3/8" 050 20 12 R PE SS +MANOMETRU
TH050.14.M0037	FR 3/8" 050 5 04 R PE SS +MANOMETRU
TH050.14.M0038	FR 3/8" 050 5 08 R PE SS +MANOMETRU
TH050.14.M0039	FR 3/8" 050 5 12 R PE SS +MANOMETRU

FILTRU REGULATOR + MANOMETRU



COD	REFERINTE
TH050.14.M0036	FR 3/8" 050 20 04 R PE SS +MANOMETRU
TH050.14.M0025	FR 3/8" 050 20 08 R PE SS +MANOMETRU
TH050.14.M0001	FR 3/8" 050 20 12 R PE SS +MANOMETRU
TH050.14.M0037	FR 3/8" 050 5 04 R PE SS +MANOMETRU
TH050.14.M0038	FR 3/8" 050 5 08 R PE SS +MANOMETRU
TH050.14.M0039	FR 3/8" 050 5 12 R PE SS +MANOMETRU

ROBINET DE INCHIDERE



COD	REFERINTE
TH050.26.00002	SV 3/8" 050 Pred. C. Electr. Microsol/Pneum.
THC50.26.00002	Kit. C.Electr. 3/2 NC 2W 24V CC Microsol
THC50.26.00003	Kit. C. Electr. 3/2 NC 1W 24V AC Microsol
THC50.26.00004	Kit. C. Electr. 3/2 NC 1W 110V AC Microsol
THC50.26.00005	Kit. C. Electr. 3/2 NC 1W 220V AC Microsol
THC40.26.00014	Pneumatic C. Kit SV
TH050.26.00001	SV 3/8" 050 Pred. C. Electr. Cnomo
THC50.26.00006	C. Electr. EV 3/2 NC Cnomo
THA50.26.00018	Bobina DC 12V Sp.=22 mm
THA50.26.00006	Bobina DC 24V Sp.=22 mm
THA50.26.00007	Bobina AC 24V Sp.=22 mm
THA50.26.00008	Bobina AC 110V Sp.=22 mm
THA50.26.00009	Bobina AC 220V Sp.=22 mm
THA50.26.00010	Conector 22 mm

ROBINET CU SLOW START



COD	REFERINTE
TH050.27.00001	AVP 3/8" 050 PN Autom.

F+R+L UNITE + MANOMETRU



COD	REFERINTE
TH050.15.M0025	F+R+L 3/8" 050 20 08 R PE SS + MANOMETRU
TH050.15.M0033	F+R+L 3/8" 050 20 12 R PE SS + MANOMETRU
TH050.15.M0034	F+R+L 3/8" 050 5 04 R PE SS + MANOMETRU
TH050.15.M0035	F+R+L 3/8" 050 5 08 R PE SS +MANOMETRU
TH050.15.M0036	F+R+L 3/8" 050 5 12 R PE SS + MANOMETRU

F+R+L UNITE



COD	REFERINTE
TH050.15.00025	F+R+L 3/8" 050 20 08 R PE SS
TH050.15.00033	F+R+L 3/8" 050 20 12 R PE SS
TH050.15.00034	F+R+L 3/8" 050 5 04 R PE SS
TH050.15.00035	F+R+L 3/8" 050 5 08 R PE SS
TH050.15.00036	F+R+L 3/8" 050 5 12 R PE SS
TH050.15.00501	F+R+L 3/8" 050 20 08 R PE SS VL
TH050.15.00505	F+R+L 3/8" 050 20 12 R PE SS VL
TH050.15.00507	F+R+L 3/8" 050 5 08 R PE SS VL
TH050.15.00509	F+R+L 3/8" 050 5 12 R PE SS VL
Purjare automata	
TH050.15.00058	F+R+L 3/8" 050 20 04 R PE SA
TH050.15.00057	F+R+L 3/8" 050 20 08 R PE SA
TH050.15.00062	F+R+L 3/8" 050 20 12 R PE SA
TH050.15.00511	F+R+L 3/8" 050 20 08 R PE SA VL
TH050.15.00513	F+R+L 3/8" 050 20 12 R PE SA VL
TH050.15.00515	F+R+L 3/8" 050 5 08 R PE SA VL
TH050.15.00518	F+R+L 3/8" 050 5 12 R PE SA VL
Diferential purjare automata	
TH050.15.00040	F+R+L 3/8" 050 20 08 R PE SAD
TH050.15.00041	F+R+L 3/8" 050 20 12 R PE SAD

FR+L UNITE



COD	REFERINTE
TH050.16.00034	FR+L 3/8" 050 20 04 R PE SS
TH050.16.00025	FR+L 3/8" 050 20 08 R PE SS
TH050.16.00001	FR+L 3/8" 050 20 12 R PE SS
TH050.16.00035	FR+L 3/8" 050 5 04 R PE SS
TH050.16.00036	FR+L 3/8" 050 5 08 R PE SS
TH050.16.00037	FR+L 3/8" 050 5 12 R PE SS
TH050.16.00501	FR+L 3/8" 050 20 08 R PE SS VL
TH050.16.00505	FR+L 3/8" 050 20 12 R PE SS VL
TH050.16.00507	FR+L 3/8" 050 5 08 R PE SS VL
TH050.16.00509	FR+L 3/8" 050 5 12 R PE SS VL
Purjare automata	
TH050.16.00058	FR+L 3/8" 050 20 04 R PE SA
TH050.16.00057	FR+L 3/8" 050 20 08 R PE SA
TH050.16.00059	FR+L 3/8" 050 20 12 R PE SA
TH050.16.00061	FR+L 3/8" 050 5 04 R PE SA
TH050.16.00060	FR+L 3/8" 050 5 08 R PE SA
TH050.16.00062	FR+L 3/8" 050 5 12 R PE SA
TH050.16.00511	FR+L 3/8" 050 20 08 R PE SA VL
TH050.16.00513	FR+L 3/8" 050 20 12 R PE SA VL
TH050.16.00515	FR+L 3/8" 050 5 08 R PE SA VL
TH050.16.00518	FR+L 3/8" 050 5 12 R PE SA VL
Diferential purjare automata	
TH050.16.00083	FR+L 3/8" 050 20 08 R PE SAD
TH050.16.00084	FR+L 3/8" 050 20 12 R PE SAD
TH050.16.00085	FR+L 3/8" 050 5 08 R PE SAD
TH050.16.00086	FR+L 3/8" 050 5 12 R PE SAD

V3+FR+L UNITE



COD	REFERINTE
TH050.36.00034	V3+FR+L 3/8" 050 20 04 R PE SS
TH050.36.00025	V3+FR+L 3/8" 050 20 08 R PE SS
TH050.36.00001	V3+FR+L 3/8" 050 20 12 R PE SS
TH050.36.00035	V3+FR+L 3/8" 050 5 04 R PE SS
TH050.36.00036	V3+FR+L 3/8" 050 5 08 R PE SS
TH050.36.00037	V3+FR+L 3/8" 050 5 12 R PE SS
TH050.36.00501	V3+FR+L 3/8" 050 20 08 R PE SS VL
TH050.36.00505	V3+FR+L 3/8" 050 20 12 R PE SS VL
TH050.36.00507	V3+FR+L 3/8" 050 5 08 R PE SS VL
TH050.36.00509	V3+FR+L 3/8" 050 5 12 R PE SS VL
Purjare automata	
TH050.36.00058	V3+FR+L 3/8" 050 20 04 R PE SA
TH050.36.00057	V3+FR+L 3/8" 050 20 08 R PE SA
TH050.36.00059	V3+FR+L 3/8" 050 20 12 R PE SA
TH050.36.00061	V3+FR+L 3/8" 050 5 04 R PE SA
TH050.36.00060	V3+FR+L 3/8" 050 5 08 R PE SA
TH050.36.00062	V3+FR+L 3/8" 050 5 12 R PE SA
TH050.36.00511	V3+FR+L 3/8" 050 20 08 R PE SA VL
TH050.36.00513	V3+FR+L 3/8" 050 20 12 R PE SA VL
TH050.36.00515	V3+FR+L 3/8" 050 5 08 R PE SA VL
TH050.36.00518	V3+FR+L 3/8" 050 5 12 R PE SA VL
Diferential purjare automata	
TH050.36.00063	V3+FR+L 3/8" 050 20 08 R PE SAD
TH050.36.00064	V3+FR+L 3/8" 050 20 12 R PE SAD
TH050.36.00065	V3+FR+L 3/8" 050 5 08 R PE SAD
TH050.36.00066	V3+FR+L 3/8" 050 5 12 R PE SAD

FR+L UNITE + MANOMETRU



COD	REFERINTE
TH050.16.M0034	FR+L 3/8" 050 20 04 R PE SS+MANOMETRU
TH050.16.M0025	FR+L 3/8" 050 20 08 R PE SS+MANOMETRU
TH050.16.M0001	FR+L 3/8" 050 20 12 R PE SS+MANOMETRU
TH050.16.M0035	FR+L 3/8" 050 5 04 R PE SS+MANOMETRU
TH050.16.M0036	FR+L 3/8" 050 5 08 R PE SS+MANOMETRU
TH050.16.M0037	FR+L 3/8" 050 5 12 R PE SS+MANOMETRU

V3+FR+L UNITE + MANOMETRU



COD	REFERINTE
TH050.36.M0034	V3+FR+L 3/8" 050 20 04 R PE SS+MANOMETRU
TH050.36.M0025	V3+FR+L 3/8" 050 20 08 R PE SS+MANOMETRU
TH050.36.M0001	V3+FR+L 3/8" 050 20 12 R PE SS+MANOMETRU
TH050.36.M0035	V3+FR+L 3/8" 050 5 04 R PE SS+MANOMETRU
TH050.36.M0036	V3+FR+L 3/8" 050 5 08 R PE SS+MANOMETRU
TH050.36.M0037	V3+FR+L 3/8" 050 5 12 R PE SS+MANOMETRU

F+L UNITE



COD	REFERINTE
TH050.17.00025	F+L 3/8" 050 20 PE SS
TH050.17.00029	F+L 3/8" 050 5 PE SS
TH050.17.00501	F+L 3/8" 050 20 PE SS VL
TH050.17.00507	F+L 3/8" 050 5 PE SS VL
Purjare automata	
TH050.17.00053	F+L 3/8" 050 20 PE SA
TH050.17.00054	F+L 3/8" 050 5 PE SA
TH050.17.00511	F+L 3/8" 050 20 PE SA VL
TH050.17.00515	F+L 3/8" 050 5 PE SA VL
Diferential purjare automata	
TH050.17.00030	F+L 3/8" 050 20 PE SAD
TH050.17.00031	F+L 3/8" 050 5 PE SAD

F+L UNITE



COD	REFERINTE
TH050.19.00001	F 3/8" 050 5 PE SS+MF 3/8" 050 0,01 PE SS
Purjare automata	
TH050.19.00002	F 3/8" 050 5 PE SS+MF 3/8" 050 0,01 PE SA
Diferential purjare automata	
TH050.19.00004	F 3/8" 050 5 PE SS+MF 3/8" 050 0,01 PE SAD

ACCESORII

SERIA 050 3/8

MANOMETRU



COD	REFERINTE
THA38.00.00114	MANOMETRU 1/8 D= 40 scala 0-2,5 bar
THA38.00.00055	MANOMETRU 1/8 D= 40 scala 0-6 bar
THA38.00.00026	MANOMETRU 1/8 D= 40 scala 0-12 bar

DISTRIBUITOR INTERMEDIAR



COD	REFERINTE
THC50.06.00002	Distribuator intermediar 2/2(1/4 + 3/8)
THC50.06.00003	Distribuator final(1/4 + 3/8)

SUPORT



COD	REFERINTE
THC75.01.00018	Suport

KIT



COD	REFERINTE
THC50.05.00001	kit pt. F+R+L - V3+FR+L unite
THC50.06.00001	kit pt. FR+L - V3+FR - F+L unite

DOP



COD	REFERINTE
THB38.00.00018	Dop tehnopolimer 1/8

PURJARE AUTOMATA "SA"



COD	REFERINTE
THC40.02.00130	Purjare automata
THC40.02.00131	kit SA / SAD

PURJARE AUTOMATA "SAD"



COD	REFERINTE
THC42.02.00012	Diferential purjare automata
THC40.02.00131	kit SA / SAD

DISTRIBUITOR INTERMEDIAR

COD	REFERINTE
THC50.05.00003	Distribuator intermediar 1/4



REGULATOR



COD	REFERINTE
TH052.11.00004	R 1/2" 052 04 R
TH052.11.*****	R 1/2" 052 08 R
TH052.11.00001	R 1/2" 052 12 R

REGULATOR + MANOMETRU



COD	REFERINTE
TH052.11.M0004	R 1/2" 052 04 R + MANOMETRU
TH052.11.M*****	R 1/2" 052 08 R + MANOMETRU
TH052.11.M0001	R 1/2" 052 12 R + MANOMETRU

FILTRU REGULATOR



COD	REFERINTE
TH052.14.00036	FR 1/2" 052 20 04 R PE SS
TH052.14.00025	FR 1/2" 052 20 08 R PE SS
TH052.14.00001	FR 1/2" 052 20 12 R PE SS
TH052.14.00037	FR 1/2" 052 5 04 R PE SS
TH052.14.00038	FR 1/2" 052 5 08 R PE SS
TH052.14.00039	FR 1/2" 052 5 12 R PE SS
Purjare automata	
TH052.14.00058	FR 1/2" 052 20 04 R PE SA
TH052.14.00057	FR 1/2" 052 20 08 R PE SA
TH052.14.00059	FR 1/2" 052 20 12 R PE SA
TH052.14.00061	FR 1/2" 052 5 04 R PE SA
TH052.14.00060	FR 1/2" 052 5 08 R PE SA
TH052.14.00062	FR 1/2" 052 5 12 R PE SA
Diferential purjare automata	
TH052.14.00063	FR 1/2" 052 20 08 R PE SAD
TH052.14.00064	FR 1/2" 052 20 12 R PE SAD
TH052.14.00065	FR 1/2" 052 5 08 R PE SAD
TH052.14.00066	FR 1/2" 052 5 12 R PE SAD

FILTRU



COD	REFERINTE
TH052.12.00025	F 1/2" 052 20 PE SS
TH052.12.00028	F 1/2" 052 5 PE SS
Purjare automata	
TH052.12.00053	F 1/2" 052 20 PE SA
TH052.12.00054	F 1/2" 052 5 PE SA
Diferential purjare automata	
TH052.12.00061	F 1/2" 052 20 PE SAD
TH052.12.00062	F 1/2" 052 5 PE SAD

FILTRU REGULATOR + MANOMETRU



COD	REFERINTE
TH052.14.M0036	FR 1/2" 052 20 04 R PE SS +MANOMETRU
TH052.14.M0025	FR 1/2" 052 20 08 R PE SS +MANOMETRU
TH052.14.M0001	FR 1/2" 052 20 12 R PE SS +MANOMETRU
TH052.14.M0037	FR 1/2" 052 5 04 R PE SS +MANOMETRU
TH052.14.M0038	FR 1/2" 052 5 08 R PE SS +MANOMETRU
TH052.14.M0039	FR 1/2" 052 5 12 R PE SS +MANOMETRU

MICROFILTRU



COD	REFERINTE
TH052.12.00010	MF 1/2" 052 0,01 PE SS
Purjare automata	
TH052.12.00060	MF 1/2" 052 0,01 PE SA
Diferential purjare automata	
TH052.12.00063	MF 1/2" 052 0,01 PE SAD

ROBINET DE INCHIDERE



COD	REFERINTE
TH052.26.00002	SV 1/2" 052 Pred. C. Electr. Microsol/Pneum.
THC50.26.00002	Kit. C.Electr. 3/2 NC 2W 24V CC Microsol
THC50.26.00003	Kit. C. Electr. 3/2 NC 1W 24V AC Microsol
THC50.26.00004	Kit. C. Electr. 3/2 NC 1W 110V AC Microsol
THC50.26.00005	Kit. C. Electr. 3/2 NC 1W 220V AC Microsol
THC40.26.00014	Pneumatic C. Kit SV

TH052.26.00001	SV 1/2" 052 Pred. C. Electr. Cnomo
THC50.26.00006	C. Electr. EV 3/2 NC Cnomo
THA50.26.00018	Bobina DC 12V Sp.=22 mm
THA50.26.00006	Bobina DC 24V Sp. 22 mm
THA50.26.00007	Bobina AC 24V Sp. 22 mm
THA50.26.00008	Bobina AC 110V Sp. 22 mm
THA50.26.00009	Bobina AC 220V Sp. 22 mm
THA50.26.00010	Conector 22 mm

UNGATOR



COD	REFERINTE
TH052.13.00025	L 1/2" 052 PE
TH052.13.00500	L 1/2" 052 PE VL
TH052.13.00034	L 1/2" 052 PE IL

ROBINET CU TREI IESIRI



COD	REFERINTE
TH052.25.00001	V1/2" 052 V3

ROBINET CU SLOW START



COD	REFERINTE
TH052.27.00001	AVP 1/2" 052 PN Autom.

REGULATOARE DE AER

SERIA 052- 1/2

F+R+L UNITE



COD	REFERINTE
TH052.15.00032	F+R+L 1/2" 052 20 04 R PE SS
TH052.15.00025	F+R+L 1/2" 052 20 08 R PE SS
TH052.15.00033	F+R+L 1/2" 052 20 12 R PE SS
TH052.15.00034	F+R+L 1/2" 052 5 04 R PE SS
TH052.15.00035	F+R+L 1/2" 052 5 08 R PE SS
TH052.15.00036	F+R+L 1/2" 052 5 12 R PE SS
TH052.15.00501	F+R+L 1/2" 052 20 08 R PE SS VL
TH052.15.00505	F+R+L 1/2" 052 20 12 R PE SS VL
TH052.15.00507	F+R+L 1/2" 052 5 08 R PE SS VL
TH052.15.00509	F+R+L 1/2" 052 5 12 R PE SS VL
Purjare automata	
TH052.15.00058	F+R+L 1/2" 052 20 04 R PE SA
TH052.15.00057	F+R+L 1/2" 052 20 08 R PE SA
TH052.15.00062	F+R+L 1/2" 052 20 12 R PE SA
TH052.15.00511	F+R+L 1/2" 052 20 08 R PE SA VL
TH052.15.00513	F+R+L 1/2" 052 20 12 R PE SA VL
TH052.15.00515	F+R+L 1/2" 052 5 08 R PE SA VL
TH052.15.00518	F+R+L 1/2" 052 5 12 R PE SA VL
Diferential purjare automata	
TH052.15.00037	F+R+L 1/2" 052 20 08 R PE SAD
TH052.15.00038	F+R+L 1/2" 052 20 12 R PE SAD

F+R+L UNITE + MANOMETRU



COD	REFERINTE
TH052.15.M0032	F+R+L 1/2" 052 20 04 R PE SS+MANOMETRU
TH052.15.M0025	F+R+L 1/2" 052 20 08 R PE SS+MANOMETRU
TH052.15.M0033	F+R+L 1/2" 052 20 12 R PE SS+MANOMETRU
TH052.15.M0034	F+R+L 1/2" 052 5 04 R PE SS+MANOMETRU
TH052.15.M0035	F+R+L 1/2" 052 5 08 R PE SS+MANOMETRU
TH052.15.M0036	F+R+L 1/2" 052 5 12 R PE SS+MANOMETRU

FR+L UNITE



COD	REFERINTE
TH052.16.00034	FR+L 1/2" 052 20 04 R PE SS
TH052.16.00025	FR+L 1/2" 052 20 08 R PE SS
TH052.16.00001	FR+L 1/2" 052 20 12 R PE SS
TH052.16.00035	FR+L 1/2" 052 5 04 R PE SS
TH052.16.00036	FR+L 1/2" 052 5 08 R PE SS
TH052.16.00037	FR+L 1/2" 052 5 12 R PE SS
TH052.16.00501	FR+L 1/2" 052 20 08 R PE SS VL
TH052.16.00505	FR+L 1/2" 052 20 12 R PE SS VL
TH052.16.00507	FR+L 1/2" 052 5 08 R PE SS VL
TH052.16.00509	FR+L 1/2" 052 5 12 R PE SS VL
Purjare automata	
TH052.16.00058	FR+L 1/2" 052 20 04 R PE SA
TH052.16.00057	FR+L 1/2" 052 20 08 R PE SA
TH052.16.00059	FR+L 1/2" 052 20 12 R PE SA
TH052.16.00061	FR+L 1/2" 052 5 04 R PE SA
TH052.16.00060	FR+L 1/2" 052 5 08 R PE SA
TH052.16.00062	FR+L 1/2" 052 5 12 R PE SA
TH052.16.00511	FR+L 1/2" 052 20 08 R PE SA VL
TH052.16.00513	FR+L 1/2" 052 20 12 R PE SA VL
TH052.16.00515	FR+L 1/2" 052 5 08 R PE SA VL
TH052.16.00518	FR+L 1/2" 052 5 12 R PE SA VL
Diferential purjare automata	
TH052.16.00063	FR+L 1/2" 052 20 08 R PE SAD
TH052.16.00064	FR+L 1/2" 052 20 12 R PE SAD
TH052.16.00065	FR+L 1/2" 052 5 08 R PE SAD
TH052.16.00066	FR+L 1/2" 052 5 12 R PE SAD

FR+L UNITE + MANOMETRU



COD	REFERINTE
TH052.16.M0034	FR+L 1/2" 052 20 04 R PE SS+MANOMETRU
TH052.16.M0025	FR+L 1/2" 052 20 08 R PE SS+MANOMETRU
TH052.16.M0001	FR+L 1/2" 052 20 12 R PE SS+MANOMETRU
TH052.16.M0035	FR+L 1/2" 052 5 04 R PE SS+MANOMETRU
TH052.16.M0036	FR+L 1/2" 052 5 08 R PE SS+MANOMETRU
TH052.16.M0037	FR+L 1/2" 052 5 12 R PE SS+MANOMETRU

V3+FR+L UNITE



COD	REFERINTE
TH052.36.00034	V3+FR+L 1/2" 052 20 04 R PE SS
TH052.36.00025	V3+FR+L 1/2" 052 20 08 R PE SS
TH052.36.00001	V3+FR+L 1/2" 052 20 12 R PE SS
TH052.36.00035	V3+FR+L 1/2" 052 5 04 R PE SS
TH052.36.00036	V3+FR+L 1/2" 052 5 08 R PE SS
TH052.36.00037	V3+FR+L 1/2" 052 5 12 R PE SS
TH052.36.00501	V3+FR+L 1/2" 052 20 08 R PE SS VL
TH052.36.00505	V3+FR+L 1/2" 052 20 12 R PE SS VL
TH052.36.00507	V3+FR+L 1/2" 052 5 08 R PE SS VL
TH052.36.00509	V3+FR+L 1/2" 052 5 12 R PE SS VL
Purjare automata	
TH052.36.00058	V3+FR+L 1/2" 052 20 04 R PE SA
TH052.36.00057	V3+FR+L 1/2" 052 20 08 R PE SA
TH052.36.00059	V3+FR+L 1/2" 052 20 12 R PE SA
TH052.36.00061	V3+FR+L 1/2" 052 5 04 R PE SA
TH052.36.00060	V3+FR+L 1/2" 052 5 08 R PE SA
TH052.36.00062	V3+FR+L 1/2" 052 5 12 R PE SA
TH052.36.00511	V3+FR+L 1/2" 052 20 08 R PE SA VL
TH052.36.00513	V3+FR+L 1/2" 052 20 12 R PE SA VL
TH052.36.00515	V3+FR+L 1/2" 052 5 08 R PE SA VL
TH052.36.00518	V3+FR+L 1/2" 052 5 12 R PE SA VL
Diferential purjare automata	
TH052.36.00063	V3+FR+L 1/2" 052 20 08 R PE SAD
TH052.36.00064	V3+FR+L 1/2" 052 20 12 R PE SAD
TH052.36.00065	V3+FR+L 1/2" 052 5 08 R PE SAD
TH052.36.00066	V3+FR+L 1/2" 052 5 12 R PE SAD

V3+FR+L UNITE + MANOMETRU



COD	REFERINTE
TH052.36.M0034	V3+FR+L 1/2" 052 20 04 R PE SS+MANOMETRU
TH052.36.M0025	V3+FR+L 1/2" 052 20 08 R PE SS+MANOMETRU
TH052.36.M0001	V3+FR+L 1/2" 052 20 12 R PE SS+MANOMETRU
TH052.36.M0035	V3+FR+L 1/2" 052 5 04 R PE SS+MANOMETRU
TH052.36.M0036	V3+FR+L 1/2" 052 5 08 R PE SS+MANOMETRU
TH052.36.M0037	V3+FR+L 1/2" 052 5 12 R PE SS+MANOMETRU

F+L UNITE



COD	REFERINTE
TH052.17.00025	F+L 1/2" 052 20 PE SS
TH052.17.00029	F+L 1/2" 052 5 PE SS
TH052.17.00501	F+L 1/2" 052 20 PE SS VL
TH052.17.00507	F+L 1/2" 052 5 PE SS VL
Purjare automata	
TH052.17.00053	F+L 1/2" 052 20 PE SA
TH052.17.00054	F+L 1/2" 052 5 PE SA
TH052.17.00511	F+L 1/2" 052 20 PE SA VL
TH052.17.00515	F+L 1/2" 052 5 PE SA VL
Diferential purjare automata	
TH052.17.00055	F+L 1/2" 052 20 PE SAD
TH052.17.00056	F+L 1/2" 052 5 PE SAD

UNITE F+MF



COD	REFERINTE
TH052.19.00001	F 1/2" 052 5 PE SS+MF 1/2" 052 0,01 PE SS
Purjare automata	
TH052.19.00002	F 1/2" 052 5 PE SS+MF 1/2" 052 0,01 PE SA
Diferential purjare automata	
TH052.19.00003	F 1/2" 052 5 PE SS+MF 1/2" 052 0,01 PE SAD

DOP



COD	REFERINTE
THB38.00.00018	Dop Tehnopolimer 1/8

PURJARE AUTOMATA "SA"



COD	REFERINTE
THC40.02.00130	Purjare automata
THC40.02.00131	kit SA / SAD

PURJARE AUTOMATA "SAD"



COD	REFERINTE
THC42.02.00012	Diferential purjare automata
THC40.02.00131	kit SA / SAD

DISTRIBUITOR INTERMEDIAR



COD	REFERINTE
THC50.05.00003	Distributor intermediar 1/4

ACCESORII

SERIA 052 - 1/2

MANOMETRU



COD	REFERINTE
THA38.00.00114	MANOMETRU 1/8 D= 40 scala 0-2,5 bar
THA38.00.00055	MANOMETRU 1/8 D= 40 scala 0-6 bar
THA38.00.00026	MANOMETRU 1/8 D= 40 scala 0-12 bar

DISTRIBUITOR DE INCHIDERE



COD	REFERINTE
THC50.06.00002	Distributor de inchidere cu intrare 1/4 + 3/8
THC50.06.00003	Distributor de inchidere cu iesire 1/4 + 3/8

SUPPORT



COD	REFERINTE
THC75.01.00018	Support

KIT



COD	REFERINTE
THC50.05.00001	KIT pt. F+R+L - V3+FR+L unite
THC50.06.00001	KIT pt. FR+L - V3+FR - F+L unite

REGULATOARE DE AER

SERIA 075 - 1/2

REGULATOR

COD	REFERINTE
TH075.11.00003	R 1/2" 075 04 R
TH075.11.****	R 1/2" 075 08 R
TH075.11.00002	R 1/2" 075 12 R



REGULATOR + MANOMETRU

COD	REFERINTE
TH075.11.M0003	R 1/2" 075 04 R + MANOMETRU
TH075.11.M****	R 1/2" 075 08 R + MANOMETRU
TH075.11.M0002	R 1/2" 075 12 R + MANOMETRU



FILTRU

COD	REFERINTE
TH075.12.00025	F 1/2" 075 20 PE SS
TH075.12.00057	F 1/2" 075 5 PE SS
Purjare automata	
TH075.12.00026	F 1/2" 075 20 PE SA
TH075.12.00058	F 1/2" 075 5 PE SA
Diferential purjare automata	
TH075.12.00076	F 1/2" 075 20 PE SAD
TH075.12.00077	F 1/2" 075 5 PE SAD



MICROFILTRU

COD	REFERINTE
TH075.12.00027	MF 1/2" 075 0,01 PE SS
Purjare automata	
TH075.12.00028	MF 1/2" 075 0,01 PE SA
Diferential purjare automata	
TH075.12.00078	MF 1/2" 075 0,01 PE SAD



UNGATOR

COD	REFERINTE
TH075.13.00025	L 1/2" 075 PE
TH075.13.00500	L 1/2" 075 PE VL
TH075.13.00032	L 1/2" 075 PE IL



FILTRU REGULATOR

COD	REFERINTE
TH075.14.00061	FR 1/2" 075 20 04 R PE SS
TH075.14.00025	FR 1/2" 075 20 08 R PE SS
TH075.14.00053	FR 1/2" 075 20 12 R PE SS
TH075.14.00062	FR 1/2" 075 5 04 R PE SS
TH075.14.00063	FR 1/2" 075 5 08 R PE SS
TH075.14.00064	FR 1/2" 075 5 12 R PE SS
Purjare automata	
TH075.14.00028	FR 1/2" 075 20 04 R PE SA
TH075.14.00026	FR 1/2" 075 20 08 R PE SA
TH075.14.00065	FR 1/2" 075 20 12 R PE SA
TH075.14.00066	FR 1/2" 075 5 04 R PE SA
TH075.14.00067	FR 1/2" 075 5 08 R PE SA
TH075.14.00068	FR 1/2" 075 5 12 R PE SA
Diferential purjare automata	
TH075.14.00097	FR 1/2" 075 20 08 R PE SAD
TH075.14.00098	FR 1/2" 075 20 12 R PE SAD
TH075.14.00099	FR 1/2" 075 5 08 R PE SAD
TH075.14.00100	FR 1/2" 075 5 12 R PE SAD



FILTRU REGULATOR + MANOMETRU

COD	REFERINTE
TH075.14.M0061	FR 1/2" 075 20 04 R PE SS +MANOMETRU
TH075.14.M0025	FR 1/2" 075 20 08 R PE SS + MANOMETRU
TH075.14.M0053	FR 1/2" 075 20 12 R PE SS + MANOMETRU
TH075.14.M0062	FR 1/2" 075 5 04 R PE SS + MANOMETRU
TH075.14.M0063	FR 1/2" 075 5 08 R PE SS + MANOMETRU
TH075.14.M0064	FR 1/2" 075 5 12 R PE SS + MANOMETRU



ROBINET CU TREI IESIRI

COD	REFERINTE
TH075.25.00001	V 1/2" 075 V3



ROBINET DE INCHIDERE

COD	REFERINTE
TH075.26.00002	SV 1/2" 075 Pred. C. Electr. Microsol/Pneum.
THC50.26.00002	Kit. C. Electr. 3/2 NC 2W 24V CC Microsol
THC50.26.00003	Kit. C. Electr. 3/2 NC 1W 24V AC Microsol
THC50.26.00004	Kit. C. Electr. 3/2 NC 1W 110V AC Microsol
THC50.26.00005	Kit. C. Electr. 3/2 NC 1W 220V AC Microsol
THC40.26.00014	Pneumatic C. Kit SV
TH075.26.00001	SV 1/2" 075 Pred. C. Electr. Cnomo
THC50.26.00006	C. Electr. EV 3/2 NC Cnomo
THA50.26.00018	Bobina DC 12V Sp.=22 mm
THA50.26.00006	Bobina DC 24V Sp.=22 mm
THA50.26.00007	Bobina AC 24V Sp.=22 mm
THA50.26.00008	Bobina AC 110V Sp.=22 mm
THA50.26.00009	Bobina AC 220V Sp.=22 mm
THA50.26.00010	Conector 22 mm



ROBINET CU SLOW START

COD	REFERINTE
TH075.27.00001	AVP1/2" 075 PN Autom.



F+R+L UNITE



COD	REFERINTE
TH075.15.00025	F+R+L 1/2" 075 20 08 R PE SS
TH075.15.00041	F+R+L 1/2" 075 20 12 R PE SS
TH075.15.00042	F+R+L 1/2" 075 5 04 R PE SS
TH075.15.00043	F+R+L 1/2" 075 5 08 R PE SS
TH075.15.00044	F+R+L 1/2" 075 5 12 R PE SS
TH075.15.00501	F+R+L 1/2" 075 20 08 R PE SS VL
TH075.15.00505	F+R+L 1/2" 075 20 12 R PE SS VL
TH075.15.00507	F+R+L 1/2" 075 5 08 R PE SS VL
TH075.15.00509	F+R+L 1/2" 075 5 12 R PE SS VL
Purjare automata	
TH075.15.00045	F+R+L 1/2" 075 20 04 R PE SA
TH075.15.00026	F+R+L 1/2" 075 20 08 R PE SA
TH075.15.00046	F+R+L 1/2" 075 20 12 R PE SA
TH075.15.00047	F+R+L 1/2" 075 5 04 R PE SA
TH075.15.00048	F+R+L 1/2" 075 5 08 R PE SA
TH075.15.00049	F+R+L 1/2" 075 5 12 R PE SA
TH075.15.00511	F+R+L 1/2" 075 20 08 R PE SA VL
TH075.15.00513	F+R+L 1/2" 075 20 12 R PE SA VL
TH075.15.00515	F+R+L 1/2" 075 5 08 R PE SA VL
TH075.15.00518	F+R+L 1/2" 075 5 12 R PE SA VL
Diferential purjare automata	
TH075.15.00067	F+R+L 1/2" 075 20 08 R PE SAD
TH075.15.00069	F+R+L 1/2" 075 20 12 R PE SAD
TH075.15.00070	F+R+L 1/2" 075 5 12 R PE SAD

V3+FR+L UNITE



COD	REFERINTE
TH075.36.00063	V3+FR+L 1/2" 075 20 04 R PE SS
TH075.36.00025	V3+FR+L 1/2" 075 20 08 R PE SS
TH075.36.00053	V3+FR+L 1/2" 075 20 12 R PE SS
TH075.36.00064	V3+FR+L 1/2" 075 5 04 R PE SS
TH075.36.00065	V3+FR+L 1/2" 075 5 08 R PE SS
TH075.36.00066	V3+FR+L 1/2" 075 5 12 R PE SS
TH075.36.00501	V3+FR+L 1/2" 075 20 08 R PE SS VL
TH075.36.00505	V3+FR+L 1/2" 075 20 12 R PE SS VL
TH075.36.00507	V3+FR+L 1/2" 075 5 08 R PE SS VL
TH075.36.00509	V3+FR+L 1/2" 075 5 12 R PE SS VL
Purjare automata	
TH075.36.00067	V3+FR+L 1/2" 075 20 04 R PE SA
TH075.36.00026	V3+FR+L 1/2" 075 20 08 R PE SA
TH075.36.00068	V3+FR+L 1/2" 075 20 12 R PE SA
TH075.36.00069	V3+FR+L 1/2" 075 5 04 R PE SA
TH075.36.00070	V3+FR+L 1/2" 075 5 08 R PE SA
TH075.36.00071	V3+FR+L 1/2" 075 5 12 R PE SA
TH075.36.00511	V3+FR+L 1/2" 075 20 08 R PE SA VL
TH075.36.00513	V3+FR+L 1/2" 075 20 12 R PE SA VL
TH075.36.00515	V3+FR+L 1/2" 075 5 08 R PE SA VL
TH075.36.00518	V3+FR+L 1/2" 075 5 12 R PE SA VL
Diferential purjare automata	
TH075.36.00072	V3+FR+L 1/2" 075 20 08 R PE SAD
TH075.36.00073	V3+FR+L 1/2" 075 20 12 R PE SAD
TH075.36.00074	V3+FR+L 1/2" 075 5 08 R PE SAD
TH075.36.00075	V3+FR+L 1/2" 075 5 12 R PE SAD

F+R+L UNITE + MANOMETRU



COD	REFERINTE
TH075.15.M0025	F+R+L 1/2" 075 20 08 R PE SS+MANOMETRU
TH075.15.M0041	F+R+L 1/2" 075 20 12 R PE SS+MANOMETRU
TH075.15.M0042	F+R+L 1/2" 075 5 04 R PE SS+MANOMETRU
TH075.15.M0043	F+R+L 1/2" 075 5 08 R PE SS+MANOMETRU
TH075.15.M0044	F+R+L 1/2" 075 5 12 R PE SS+MANOMETRU

FR+L UNITE



COD	REFERINTE
TH075.16.00063	FR+L 1/2" 075 20 04 R PE SS
TH075.16.00025	FR+L 1/2" 075 20 08 R PE SS
TH075.16.00053	FR+L 1/2" 075 20 12 R PE SS
TH075.16.00064	FR+L 1/2" 075 5 04 R PE SS
TH075.16.00065	FR+L 1/2" 075 5 08 R PE SS
TH075.16.00066	FR+L 1/2" 075 5 12 R PE SS
TH075.16.00501	FR+L 1/2" 075 20 08 R PE SS VL
TH075.16.00505	FR+L 1/2" 075 20 12 R PE SS VL
TH075.16.00507	FR+L 1/2" 075 5 08 R PE SS VL
TH075.16.00509	FR+L 1/2" 075 5 12 R PE SS VL
Purjare automata	
TH075.16.00067	FR+L 1/2" 075 20 04 R PE SA
TH075.16.00026	FR+L 1/2" 075 20 08 R PE SA
TH075.16.00068	FR+L 1/2" 075 20 12 R PE SA
TH075.16.00069	FR+L 1/2" 075 5 04 R PE SA
TH075.16.00070	FR+L 1/2" 075 5 08 R PE SA
TH075.16.00071	FR+L 1/2" 075 5 12 R PE SA
TH075.16.00511	FR+L 1/2" 075 20 08 R PE SA VL
TH075.16.00513	FR+L 1/2" 075 20 12 R PE SA VL
TH075.16.00515	FR+L 1/2" 075 5 08 R PE SA VL
TH075.16.00518	FR+L 1/2" 075 5 12 R PE SA VL
Diferential purjare automata	
TH075.16.00096	FR+L 1/2" 075 20 08 R PE SAD
TH075.16.00097	FR+L 1/2" 075 20 12 R PE SAD
TH075.16.00098	FR+L 1/2" 075 5 08 R PE SAD
TH075.16.00099	FR+L 1/2" 075 5 12 R PE SAD

FR+L UNITE + MANOMETRU



COD	REFERINTE
TH075.16.M0063	FR+L 1/2" 075 20 04 R PE SS + MANOMETRU
TH075.16.M0025	FR+L 1/2" 075 20 08 R PE SS + MANOMETRU
TH075.16.M0053	FR+L 1/2" 075 20 12 R PE SS + MANOMETRU
TH075.16.M0064	FR+L 1/2" 075 5 04 R PE SS + MANOMETRU
TH075.16.M0065	FR+L 1/2" 075 5 08 R PE SS + MANOMETRU
TH075.16.M0066	FR+L 1/2" 075 5 12 R PE SS + MANOMETRU

V3+FR+L UNITE + MANOMETRU



COD	REFERINTE
TH075.36.M0063	V3+FR+L 1/2" 075 20 04 R PE SS+MANOMETRU
TH075.36.M0025	V3+FR+L 1/2" 075 20 08 R PE SS+MANOMETRU
TH075.36.M0053	V3+FR+L 1/2" 075 20 12 R PE SS+MANOMETRU
TH075.36.M0064	V3+FR+L 1/2" 075 5 04 R PE SS+MANOMETRU
TH075.36.M0065	V3+FR+L 1/2" 075 5 08 R PE SS+MANOMETRU
TH075.36.M0066	V3+FR+L 1/2" 075 5 12 R PE SS+MANOMETRU

REGULATOARE DE AER

SERIA 075 - 1/2

F+L UNITE



COD	REFERINTE
TH075.17.00025	F+L 1/2" 075 20 PE SS
TH075.17.00031	F+L 1/2" 075 5 PE SS
TH075.17.00501	F+L 1/2" 075 20 PE SS VL
TH075.17.00507	F+L 1/2" 075 5 PE SS VL
Purjare automata	
TH075.17.00026	F+L 1/2" 075 20 PE SA
TH075.17.00032	F+L 1/2" 075 5 PE SA
TH075.17.00511	F+L 1/2" 075 20 PE SA VL
TH075.17.00515	F+L 1/2" 075 5 PE SA VL
Diferential purjare automata	
TH075.17.00033	F+L 1/2" 075 20 PE SAD
TH075.17.00034	F+L 1/2" 075 5 PE SAD

UNITE F+MF



COD	REFERINTE
TH075.19.00001	F 1/2" 075 5 PE SS+MF 1/2" 075 0,01 PE SS Purjare automata
TH075.19.00002	F 1/2" 075 5 PE SS+MF 1/2" 075 0,01 PE SA Diferential purjare automata
TH075.19.00004	F 1/2" 075 5 PE SS+MF 1/2" 075 0,01 PE SAD

ACCESORII

SERIA 075 - 1/2

MANOMETRU



COD	REFERINTE
THA75.01.00010	MANOMETRU 1/8 D= 50 scala 0-12 bar
THA75.01.00011	MANOMETRU 1/8 D=50 scala 0-6 bar

PURJARE AUTOMATA "SAD"



COD	REFERINTE
THC42.02.00012	Diferential purjare automata
THC40.02.00131	KIT SA / SAD

SUPORT



COD	REFERINTE
THC75.01.00018	Suport

DISTRIBUITOR INTERMEDIAR



COD	REFERINTE
THC75.06.00002	Distribuator intermediar 1/4

DOP



COD	REFERINTE
THB38.00.00018	Dop Tehnopolimer 1/8

DISTRIBUITOR DE INCHIDERE



COD	REFERINTE
THC75.06.00004	Distribuator de inchidere cu intrare 1/4 + 1/2
THC75.06.00005	Distribuator de inchidere cu iesire 1/4 + 1/2

PURJARE AUTOMATA "SA"



COD	REFERINTE
THC40.02.00130	Purjare automata
THC40.02.00131	KIT SA / SAD

KIT



COD	REFERINTE
THC75.05.00001	KIT pt. F+R+L - V3+FR+L unite
THC75.06.00001	KIT pt. FR+L - V3+FR - F+L unite

REGULATOR



COD	REFERINTE
TH080.01.00002	R 3/4" 080 04 R
TH080.01.00001	R 3/4" 080 08 R
TH080.01.00003	R 3/4" 080 12 R

F+R+L UNITE + MANOMETRU



COD	REFERINTE
TH080.01.M0002	R 3/4" 080 04 R + MANOMETRU
TH080.01.M0001	R 3/4" 080 08 R + MANOMETRU
TH080.01.M0003	R 3/4" 080 12 R + MANOMETRU



FILTRU



COD	REFERINTE
TH080.02.00001	F 3/4" 080 20 PE SS
TH080.02.00002	F 3/4" 080 5 PE SS
Purjare automata	
TH080.02.00003	F 3/4" 080 20 PE SA
TH080.02.00004	F 3/4" 080 5 PE SA
Diferential purjare automata	
TH080.02.00010	F 3/4" 080 20 PE SAD
TH080.02.00011	F 3/4" 080 5 PE SAD

MICROFILTRU



COD	REFERINTE
TH080.02.00301	MF 3/4" 080 0,01 PE SS
Purjare automata	
TH080.02.00302	MF 3/4" 080 0,01 PE SA
Diferential purjare automata	
TH080.02.00305	MF 3/4" 080 0,01 PE SAD

UNGATOR



COD	REFERINTE
TH080.03.00001	L 3/4" 080 PE
TH080.03.00500	L 3/4" 080 PE VL
TH080.03.00005	L 3/4" 080 PE IL

FILTRU REGULATOR



COD	REFERINTE
TH080.04.00002	FR 3/4" 080 20 04 R PE SS
TH080.04.00001	FR 3/4" 080 20 08 R PE SS
TH080.04.00003	FR 3/4" 080 20 12 R PE SS
TH080.04.00005	FR 3/4" 080 5 04 R PE SS
TH080.04.00004	FR 3/4" 080 5 08 R PE SS
TH080.04.00006	FR 3/4" 080 5 12 R PE SS
Purjare automata	
TH080.04.00008	FR 3/4" 080 20 04 R PE SA
TH080.04.00007	FR 3/4" 080 20 08 R PE SA
TH080.04.00009	FR 3/4" 080 20 12 R PE SA
TH080.04.00011	FR 3/4" 080 5 04 R PE SA
TH080.04.00010	FR 3/4" 080 5 08 R PE SA
TH080.04.00012	FR 3/4" 080 5 12 R PE SA
Diferential purjare automata	
TH080.04.00026	FR 3/4" 080 20 08 R PE SAD
TH080.04.00027	FR 3/4" 080 20 12 R PE SAD
TH080.04.00028	FR 3/4" 080 5 08 R PE SAD
TH080.04.00029	FR 3/4" 080 5 12 R PE SAD

FILTRU REGULATOR + MANOMETRU



COD	REFERINTE
TH080.04.M0002	FR 3/4" 080 20 04 R PE SS + MANOMETRU
TH080.04.M0001	FR 3/4" 080 20 08 R PE SS + MANOMETRU
TH080.04.M0003	FR 3/4" 080 20 12 R PE SS + MANOMETRU
TH080.04.M0005	FR 3/4" 080 5 04 R PE SS + MANOMETRU
TH080.04.M0004	FR 3/4" 080 5 08 R PE SS + MANOMETRU
TH080.04.M0006	FR 3/4" 080 5 12 R PE SS + MANOMETRU

ROBINET DE IESIRE



COD	REFERINTE
TH080.26.00002	SV 3/4" 080 Pred. C. Electr. Microsol/Pneum.
THC80.26.00002	Kit SV 3/4" 080 Pred. C. Electr. Microsol fara reglare manuala
THC50.26.00002	Kit. C. Elec tr. 3/2 NC 2W 24V CC Microsol
THC50.26.00003	Kit. C. Electr. 3/2 NC 1W 24V AC Microsol
THC50.26.00004	Kit. C. Electr. 3/2 NC 1W 110V AC Microsol
THC50.26.00005	Kit. C. Electr. 3/2 NC 1W 220V AC Microsol
THC40.26.00014	Pneumatic C. Kit SV
TH080.26.00001	SV 3/4" 080 Pred. C. Electr. Cnomo
THC80.26.00001	Kit SV 3/4" 080 Pred. C. Electr. Cnomo fara reglare manuala
THC50.26.00006	C. Electr. EV 3/2 NC Cnomo
THA50.26.00018	Bobina DC 12V Sp.=22 mm
THA50.26.00006	Bobina DC 24V Sp.=22 mm
THA50.26.00007	Bobina AC 24V Sp.=22 mm
THA50.26.00008	Bobina AC 110V Sp.=22 mm
THA50.26.00009	Bobina AC 220V Sp.=22 mm
THA50.26.00010	Conector 22 mm

REGULATOR DE AER

SERIA 080 - 3/4

ROBINET CU TREI IESIRI



COD	REFERINTE
TH080.25.00001	V 3/4" 080 V3
THC80.25.00001	Kit V 3/4" 080 V3 fara reglare manuala

ROBINET CU SLOW START



COD	REFERINTE
TH080.27.00001	AVP 3/4" 080 PN Autom.
THC80.27.00001	Kit AVP 3/4" 080 PN Autom. Fara reglare manuala

F+R+L UNITE + MANOMETRU



COD	REFERINTE
TH080.05.M0002	F+R+L 3/4" 080 20 04 R PE SS+MANOMETRU
TH080.05.M0001	F+R+L 3/4" 080 20 08 R PE SS+MANOMETRU
TH080.05.M0003	F+R+L 3/4" 080 20 12 R PE SS+MANOMETRU
TH080.05.M0005	F+R+L 3/4" 080 5 04 R PE SS+MANOMETRU
TH080.05.M0004	F+R+L 3/4" 080 5 08 R PE SS+MANOMETRU
TH080.05.M0006	F+R+L 3/4" 080 5 12 R PE SS+MANOMETRU

FR+L UNITE + MANOMETRU



COD	REFERINTE
TH080.06.M0002	FR+L 3/4" 080 20 04 R PE SS + MANOMETRU
TH080.06.M0001	FR+L 3/4" 080 20 08 R PE SS + MANOMETRU
TH080.06.M0003	FR+L 3/4" 080 20 12 R PE SS + MANOMETRU
TH080.06.M0005	FR+L 3/4" 080 5 04 R PE SS + MANOMETRU
TH080.06.M0004	FR+L 3/4" 080 5 08 R PE SS + MANOMETRU
TH080.06.M0006	FR+L 3/4" 080 5 12 R PE SS + MANOMETRU

V3+FR+L UNITE+ MANOMETRU



COD	REFERINTE
TH080.36.M0002	V3+FR+L 3/4" 080 20 04 R PE SS+MANOMETRU
TH080.36.M0001	V3+FR+L 3/4" 080 20 08 R PE SS+MANOMETRU
TH080.36.M0003	V3+FR+L 3/4" 080 20 12 R PE SS+MANOMETRU
TH080.36.M0005	V3+FR+L 3/4" 080 5 04 R PE SS+MANOMETRU
TH080.36.M0004	V3+FR+L 3/4" 080 5 08 R PE SS+MANOMETRU
TH080.36.M0006	V3+FR+L 3/4" 080 5 12 R PE SS+MANOMETRU

F+MF UNITE



COD	REFERINTE
TH080.09.00001	Purjare automata
TH080.09.00002	Diferential purjare automata
TH080.09.00003	

F+R+L UNITE



COD	REFERINTE
TH080.05.00002	F+R+L 3/4" 080 20 04 R PE SS
TH080.05.00001	F+R+L 3/4" 080 20 08 R PE SS
TH080.05.00003	F+R+L 3/4" 080 20 12 R PE SS
TH080.05.00005	F+R+L 3/4" 080 5 04 R PE SS
TH080.05.00004	F+R+L 3/4" 080 5 08 R PE SS
TH080.05.00006	F+R+L 3/4" 080 5 12 R PE SS
TH080.05.00501	F+R+L 3/4" 080 20 08 R PE SS VL
TH080.05.00505	F+R+L 3/4" 080 20 12 R PE SS VL
TH080.05.00507	F+R+L 3/4" 080 5 08 R PE SS VL
TH080.05.00509	F+R+L 3/4" 080 5 12 R PE SS VL
Purjare automata	
TH080.05.00008	F+R+L 3/4" 080 20 04 R PE SA
TH080.08.00007	F+R+L 3/4" 080 20 08 R PE SA
TH080.05.00009	F+R+L 3/4" 080 20 12 R PE SA
TH080.05.00011	F+R+L 3/4" 080 5 04 R PE SA
TH080.05.00010	F+R+L 3/4" 080 5 08 R PE SA
TH080.05.00012	F+R+L 3/4" 080 5 12 R PE SA
TH080.05.00511	F+R+L 3/4" 080 20 08 R PE SA VL
TH080.05.00513	F+R+L 3/4" 080 20 12 R PE SA VL
TH080.05.00515	F+R+L 3/4" 080 5 08 R PE SA VL
TH080.05.00518	F+R+L 3/4" 080 5 12 R PE SA VL
Diferential purjare automata	
TH080.05.00026	F+R+L 3/4" 080 20 08 R PE SAD
TH080.05.00027	F+R+L 3/4" 080 20 12 R PE SAD
TH080.05.00028	F+R+L 3/4" 080 5 08 R PE SAD
TH080.05.00029	F+R+L 3/4" 080 5 12 R PE SAD

FR+L UNITE



COD	REFERINTE
TH080.06.00002	FR+L 3/4" 080 20 04 R PE SS
TH080.06.00001	FR+L 3/4" 080 20 08 R PE SS
TH080.06.00003	FR+L 3/4" 080 20 12 R PE SS
TH080.06.00005	FR+L 3/4" 080 5 04 R PE SS
TH080.06.00004	FR+L 3/4" 080 5 08 R PE SS
TH080.06.00006	FR+L 3/4" 080 5 12 R PE SS
TH080.06.00501	FR+L 3/4" 080 20 08 R PE SS VL
TH080.06.00505	FR+L 3/4" 080 20 12 R PE SS VL
TH080.06.00507	FR+L 3/4" 080 5 08 R PE SS VL
TH080.06.00509	FR+L 3/4" 080 5 12 R PE SS VL
Purjare automata	
TH080.06.00008	FR+L 3/4" 080 20 04 R PE SA
TH080.06.00007	FR+L 3/4" 080 20 08 R PE SA
TH080.06.00009	FR+L 3/4" 080 20 12 R PE SA
TH080.06.00011	FR+L 3/4" 080 5 04 R PE SA
TH080.06.00010	FR+L 3/4" 080 5 08 R PE SA
TH080.06.00012	FR+L 3/4" 080 5 12 R PE SA
TH080.06.00511	FR+L 3/4" 080 20 08 R PE SA VL
TH080.06.00513	FR+L 3/4" 080 20 12 R PE SA VL
TH080.06.00515	FR+L 3/4" 080 5 08 R PE SA VL
TH080.06.00518	FR+L 3/4" 080 5 12 R PE SA VL
Diferential purjare automata	
TH080.06.00028	FR+L 3/4" 080 20 08 R PE SAD
TH080.06.00029	FR+L 3/4" 080 20 12 R PE SAD
TH080.06.00030	FR+L 3/4" 080 5 08 R PE SAD
TH080.06.00031	FR+L 3/4" 080 5 12 R PE SAD

V3+FR+L UNITE



COD	REFERINTE
TH080.36.00002	V3+FR+L 3/4" 080 20 04 R PE SS
TH080.36.00001	V3+FR+L 3/4" 080 20 08 R PE SS
TH080.36.00003	V3+FR+L 3/4" 080 20 12 R PE SS
TH080.36.00005	V3+FR+L 3/4" 080 5 04 R PE SS
TH080.36.00004	V3+FR+L 3/4" 080 5 08 R PE SS
TH080.36.00006	V3+FR+L 3/4" 080 5 12 R PE SS
TH080.36.00501	V3+FR+L 3/4" 080 20 08 R PE SS VL
TH080.36.00505	V3+FR+L 3/4" 080 20 12 R PE SS VL
TH080.36.00507	V3+FR+L 3/4" 080 5 08 R PE SS VL
TH080.36.00509	V3+FR+L 3/4" 080 5 12 R PE SS VL
Purjare automata	
TH080.36.00008	V3+FR+L 3/4" 080 20 04 R PE SA
TH080.36.00007	V3+FR+L 3/4" 080 20 08 R PE SA
TH080.36.00009	V3+FR+L 3/4" 080 20 12 R PE SA
TH080.36.00011	V3+FR+L 3/4" 080 5 04 R PE SA
TH080.36.00010	V3+FR+L 3/4" 080 5 08 R PE SA
TH080.36.00012	V3+FR+L 3/4" 080 5 12 R PE SA
TH080.36.00511	V3+FR+L 3/4" 080 20 08 R PE SA VL
TH080.36.00513	V3+FR+L 3/4" 080 20 12 R PE SA VL
TH080.36.00515	V3+FR+L 3/4" 080 5 08 R PE SA VL
TH080.36.00518	V3+FR+L 3/4" 080 5 12 R PE SA VL
Diferential purjare automata	
TH080.36.00013	V3+FR+L 3/4" 080 20 08 R PE SAD
TH080.36.00014	V3+FR+L 3/4" 080 20 12 R PE SAD
TH080.36.00015	V3+FR+L 3/4" 080 5 08 R PE SAD
TH080.36.00016	V3+FR+L 3/4" 080 5 12 R PE SAD

F+L UNITE



COD	REFERINTE
TH080.07.00001	F+L 3/4" 080 20 PE SS
TH080.07.00002	F+L 3/4" 080 5 PE SS
TH080.07.00501	F+L 3/4" 080 20 PE SS VL
TH080.07.00507	F+L 3/4" 080 5 PE SS VL
Purjare automata	
TH080.07.00004	F+L 3/4" 080 5 PE SA
TH080.07.00003	F+L 3/4" 080 20 PE SA
TH080.07.00511	F+L 3/4" 080 20 PE SA VL
TH080.07.00515	F+L 3/4" 080 5 PE SA VL
Diferential purjare automata	
TH080.07.00005	F+L 3/4" 080 20 PE SAD
TH080.07.00006	F+L 3/4" 080 5 PE SAD

ACCESORII

SERIA 080 - 3/4

MANOMETRU



COD	REFERINTE
THA75.01.00011	MANOMETRU 1/8 D= 50 scala 0-6 bar
THA75.01.00010	MANOMETRU 1/8 D= 50 scala 0-12 bar

SUPORT



COD	REFERINTE
THC75.01.00018	Suport

DOP



COD	REFERINTE
THB38.00.00018	Dop Tehnopolimer 1/8

PURJARE AUTOMATA "SA"



COD	REFERINTE
THC40.02.00130	Purjare automata
THC40.02.00131	KIT SA / SAD

PURJARE AUTOMATA "SAD"



COD	REFERINTE
THC42.02.00012	Diferential purjare automata
THC40.02.00131	KIT SA / SAD

DISTRIBUITOR INTERMEDIER



COD	REFERINTE
THC80.06.00005	Distribuator intermediar 1/4

KIT



COD	REFERINTE
THC80.05.00004	KIT pt. F+R+L - V3+FR+L unite
THC80.06.00004	KIT pt. FR+L - V3+FR - F+L unite

REGULATOARE DE AER

SERIA 095 -1"

PLACA CU O INTRARE SI O IESIRE G3/4



COD	REFERINTE
THC80.05.00002	PLACA CU O INTRARE 3/4
THC80.05.00003	PLACA CU O IESIRE 3/4

REGULATOR



COD	REFERINTE
TH095.01.00002	R 1" 095 04 R
TH095.01.00001	R 1" 095 08 R
TH095.01.00003	R 1" 095 12 R

REGULATOR + MANOMETRU



COD	REFERINTE
TH095.01.M0002	R 1" 095 04 R
TH095.01.M0002	R 1" 095 08 R
TH095.01.M0003	R 1" 095 12 R

FILTRU



COD	REFERINTE
TH095.02.00001	F 1" 095 20 PE SS
TH095.02.00002	F 1" 095 5 PE SS
Purjare automata	
TH095.02.00003	F 1" 095 20 PE SA
TH095.02.00004	F 1" 095 5 PE SA
Diferential purjare automata	
TH095.02.00007	F 1" 095 20 PE SAD
TH095.02.00008	F 1" 095 5 PE SAD

UNGATOR



COD	REFERINTE
TH095.03.00001	L 1" 095 PE
TH095.03.00002	L 1" 095 PE IL (cu indice minim de nivel)
TH095.03.00003	L 1" 095 PE IM (cu indice minim si maxim de nivel)

FILTRU REGULATOR + MANOMETRU



COD	REFERINTE
TH095.04.M0002	FR 1" 095 20 04 R PE SS + MANOMETRU
TH095.04.M0001	FR 1" 095 20 08 R PE SS + MANOMETRU
TH095.04.M0003	FR 1" 095 20 12 R PE SS + MANOMETRU
TH095.04.M0005	FR 1" 095 5 04 R PE SS + MANOMETRU
TH095.04.M0004	FR 1" 095 5 08 R PE SS + MANOMETRU
TH095.04.M0006	FR 1" 095 5 12 R PE SS + MANOMETRU

FILTRU REGULATOR



COD	REFERINTE
TH095.04.00002	FR 1" 095 20 04 R PE SS
TH095.04.00001	FR 1" 095 20 08 R PE SS
TH095.04.00003	FR 1" 095 20 12 R PE SS
TH095.04.00005	FR 1" 095 5 04 R PE SS
TH095.04.00004	FR 1" 095 5 08 R PE SS
TH095.04.00006	FR 1" 095 5 12 R PE SS
Purjare automata	
TH095.04.00008	FR 1" 095 20 04 R PE SA
TH095.04.00007	FR 1" 095 20 08 R PE SA
TH095.04.00009	FR 1" 095 20 12 R PE SA
TH095.04.00011	FR 1" 095 5 04 R PE SA
TH095.04.00010	FR 1" 095 5 08 R PE SA
TH095.04.00012	FR 1" 095 5 12 R PE SA
Diferential purjare automata	
TH095.04.00014	FR 1" 095 20 08 R PE SAD
TH095.04.00016	FR 1" 095 5 08 R PE SAD
TH095.04.00017	FR 1" 095 5 12 R PE SAD

F+R+L UNITE



COD	REFERINTE
TH095.05.00002	F+R+L 1" 095 20 04 R PE SS
TH095.05.00001	F+R+L 1" 095 20 08 R PE SS
TH095.05.00003	F+R+L 1" 095 20 12 R PE SS
TH095.05.00005	F+R+L 1" 095 5 04 R PE SS
TH095.05.00004	F+R+L 1" 095 5 08 R PE SS
TH095.05.00006	F+R+L 1" 095 5 12 R PE SS
Purjare automata	
TH095.05.00008	F+R+L 1" 095 20 04 R PE SA
TH095.05.00007	F+R+L 1" 095 20 08 R PE SA
TH095.05.00009	F+R+L 1" 095 20 12 R PE SA
TH095.05.00011	F+R+L 1" 095 5 04 R PE SA
TH095.05.00010	F+R+L 1" 095 5 08 R PE SA
TH095.05.00012	F+R+L 1" 095 5 12 R PE SA
Diferential purjare automata	
TH095.05.00013	F+R+L 1" 095 20 08 R PE SAD
TH095.05.00014	F+R+L 1" 095 20 12 R PE SAD
TH095.05.00015	F+R+L 1" 095 5 08 R PE SAD
TH095.05.00016	F+R+L 1" 095 5 12 R PE SAD

F+R+L UNITE + MANOMETRU



COD	REFERINTE
TH095.05.M0002	F+R+L 1" 095 20 04 R PE SS+MANOMETRU
TH095.05.M0001	F+R+L 1" 095 20 08 R PE SS+MANOMETRU
TH095.05.M0003	F+R+L 1" 095 20 12 R PE SS+MANOMETRU
TH095.05.M0005	F+R+L 1" 095 5 04 R PE SS+MANOMETRU
TH095.05.M0004	F+R+L 1" 095 5 08 R PE SS+MANOMETRU
TH095.05.M0006	F+R+L 1" 095 5 12 R PE SS+MANOMETRU

FR+L UNITE + MANOMETRU



COD	REFERINTE
TH095.06.M0002	FR+L 1" 095 20 04 R PE SS +MANOMETRU
TH095.06.M0001	FR+L 1" 095 20 08 R PE SS +MANOMETRU
TH095.06.M0003	FR+L 1" 095 20 12 R PE SS +MANOMETRU
TH095.06.M0005	FR+L 1" 095 5 04 R PE SS +MANOMETRU
TH095.06.M0004	FR+L 1" 095 5 08 R PE SS +MANOMETRU
TH095.06.M0006	FR+L 1" 095 5 12 R PE SS +MANOMETRU

FR+L UNITE



COD	REFERINTE
TH095.06.00002	FR+L 1" 095 20 04 R PE SS
TH095.06.00001	FR+L 1" 095 20 08 R PE SS
TH095.06.00003	FR+L 1" 095 20 12 R PE SS
TH095.06.00005	FR+L 1" 095 5 04 R PE SS
TH095.06.00004	FR+L 1" 095 5 08 R PE SS
TH095.06.00006	FR+L 1" 095 5 12 R PE SS
Purjare automata	
TH095.06.00008	FR+L 1" 095 20 04 R PE SA
TH095.06.00007	FR+L 1" 095 20 08 R PE SA
TH095.06.00009	FR+L 1" 095 20 12 R PE SA
TH095.06.00011	FR+L 1" 095 5 04 R PE SA
TH095.06.00010	FR+L 1" 095 5 08 R PE SA
TH095.06.00012	FR+L 1" 095 5 12 R PE SA
Diferential purjare automata	
TH095.06.00013	FR+L 1" 095 20 08 R PE SAD
TH095.06.00014	FR+L 1" 095 20 12 R PE SAD
TH095.06.00016	FR+L 1" 095 5 12 R PE SAD

PURJARE AUTOMATA "SA"



COD	REFERINTE
THC40.02.00130	Purjare automata
THC40.02.00131	KIT SA / SAD

PURJARE AUTOMATA "SAD"



COD	REFERINTE
THC42.02.00012	Diferential purjare automata
THC40.02.00131	KIT SA / SAD

F+L UNITE



COD	REFERINTE
TH095.07.00001	F+L 1" 095 20 PE SS
TH095.07.00002	F+L 1" 095 5 PE SS
Purjare automata	
TH095.07.00003	F+L 1" 095 20 PE SA
TH095.07.00004	F+L 1" 095 5 PE SA
Diferential purjare automata	
TH095.07.00005	F+L 1" 095 20 PE SA
TH095.07.00006	F+L 1" 095 5 PE SA

SUPPORT LATERAL



COD	REFERINTE
THC95.01.00018	Support

KIT SUPORT LATERAL



COD	REFERINTE
THC95.01.00015	KIT SUPORT

ACCESORII

SERIA 095 - 1"

MANOMETRU



COD	REFERINTE
THA95.01.00026	MANOMETRU 1/4 D= 63 scala 0-12 bar

KIT



COD	REFERINTE
THC95.05.00001	KIT pt. F+R+L unite
THC95.06.00001	KIT pt. FR+L - F+L unite

DOP



COD	REFERINTE
THA95.01.00030	Dop metalic 1/4

PIESE DE SCHIMB

ARC



COD	LINIE	PRODUS	PRESIUNEA
THA35.01.00006	035	MR	035
THA38.00.00039	038-038P-039	MR-RFR	038-038P-039
THA38.00.00040	038-038P-039-042	MR-RFR	038-038P-039-042
THA38.00.00020	038-038P-039-042	MR-RFR	038-038P-039-042
THA38.00.00021	038-038P-039-042	MR-RFR	038-038P-039-042
THA50.01.00006	050-052	R-FR	050-052
THA50.01.00007	050-052	R-FR	050-052
THA50.01.00008	050-052	R-FR	050-052
THA75.01.00030	075-080	R-FR	075-080
THA75.01.00031	075-080	R-FR	075-080
THA75.01.00032	075-080	R-FR	075-080

GARNITURA COMPLETA



COD	LINIE	PRODUS	SCURGERE
THC38.00.00049	035	MR-RFR	Purjare
THC38.00.00073	038	MR	Purjare
THC38.00.00109	038P	MR	Purjare
THC39.00.00009	039	MR	Purjare
THC42.01.00013	042	R-FR	Purjare
THC50.01.00021	050	R-FR	Purjare
THC75.01.00023	075-080	R-FR	Purjare
THC38.00.00050	035	MR-MR P	NON PURJARE
THC38.00.00074	038	MR	NON PURJARE
THC38.00.00087	038	MR LC	NON PURJARE
THC38.00.00110	038P	MR	NON PURJARE
THC39.00.00069	039 INOX	MR INOX	NON PURJARE
THC39.00.00010	039	MR	NON PURJARE
THC42.01.00014	042	R-FR	NON PURJARE

PAHAR PROTECTIE FILTRU REGULATOR



COD	LINIE	PRODUS	SCURGERE
THC35.02.00004	035	F	Manual
THC35.03.00001	035	F	APA
THC40.02.00062	042	F-FR	Manual / Semi-automatic
THC40.02.00036	042	F-FR (TC version)	Manual / Semi-automatic
THC40.02.00133	042	F-FR	Automatic
THC40.03.00082	042	L	
THC40.03.00047	042	L (TC version)	
THC40.03.01016	042	L (VL)	

ELEMENT FILTRARE CU PROTECTIE



COD	LINIE	PRODUS	GRAD DE FILTRARE
THA95.02.00006	095	F-FR	20 µm
THA95.02.000076	095	F-FR	5 µm

PAHAR CU CAPAC DE PROTECTIE



COD	LINIE	PRODUS	SCURGERE
THC40.02.00108	042	F-FR	Manual / Semi-automatic
THC50.02.00002	050-052	F-FR	Manual / Semi-automatic
THC75.02.00022	075-080	F-FR	Manual / Semi-automatic
THC95.02.00005	095	F-FR	Manual / Semi-automatic
THC40.02.00134	042	F-FR	Flotare automata
THC50.02.00038	050-052	F-FR	Flotare automata
THC75.02.00026	075-080	F-FR	Flotare automata
THC95.02.00006	095	F-FR	Flotare automata
THC40.03.00084	042	L	
THC50.03.00001	050-052	L	
THC75.03.00022	075-080	L	
THC95.03.00004	095	L	
THC40.03.01017	042	L (VL)	
THC50.03.00038	050-052	L (IL)	
THC50.13.01001	050-052	L (VL)	
THC75.13.01000	075-080	L (VL)	
THC75.03.00075	075-080	L (IL)	
THC95.03.00007	095	L (IL)	
THC95.03.00009	095	L (IM)	

ELEMENT FILTRARE



COD	LINIE	PRODUS	GRAD DE FILTRARE
THC35.02.00006	035	F	20 µm
THC35.02.00005	035	F	80 µm
THC40.02.00101	042	F	20 µm
THC50.02.00005	050	F	20 µm
THC50.02.00018	050	FR	20 µm
THC75.02.00059	075-080	F	20 µm
THC75.02.00064	075-080	FR	20 µm
THC35.02.00010	035	F	5 µm
THC40.02.00106	042	F	5 µm
THC42.04.00001	042	FR	20 µm
THC42.04.00005	042	FR	5 µm
THC50.02.00006	050-052	F	5 µm
THC50.02.00019	050-052	FR	5 µm
THC75.02.00063	075-080	F	5 µm
THC75.02.00065	075-080	FR	5 µm

ELEMENT FILTRARE PENTRU MICROFILTRU



COD	LINIE	PRODUS	GRAD DE FILTRARE
THC35.02.00007	035	MF 1/8"	0,01 µm
THC40.02.00053	042	MF 1/4"	0,01 µm
THC50.02.00007	050-052	MF 3/8"	0,01 µm
THC75.02.00061	075-080	MF 1/2"-MF 3/4"	0,01 µm

ELEMENT FILTRARE ULEI



COD	LINIE	PRODUS
THC75.03.00073	042-050-052-075-080-095	L

ELEMENT TRANSPARENT DE FILTRARE ULEI



COD	LINIE	PRODUS
THC42.03.00005	042-050-052	L
THC75.03.00018	075-080-095	L

GHID DE REFERINȚE

AMORTIZOR DE ZGOMOT



COD	REFERINȚA	CONEXIUNEA
THD00.00.12025	Conveyor-x 25	1/2"
THD00.00.10050	Conveyor-x 50	1"
THD00.00.15150	Conveyor-x 150	1"½

ELEMENT DE SCURGERE PRIN PICURARE



COD	REFERINȚA	CONEXIUNEA
TH010.00.00001	S.A.L.	1/2"

INDEXUL PRODUSELOR

p.40 MINIDISTRIBUITOARE

p.42 BUTOANE DISTRIBUTOARE PANOU

p.43 DISTRIBUTOARE CU ACTIONARE
ELECTRICA SERIA 110

p.46 DISTRIBUTOARE CU ACTIONARE
ELECTROPNEUMATICA

p.48 DISTRIBUTOARE SERIA 120



DISTRIBUITOARE INDEX

p.51 DISTRIBUTOARE SERIA 125

p.54 DISTRIBUTOARE SERIA 127

p.58 BUTOANE DISTRIBUTOARE PANOU

p.59 DISTRIBUTOARE SERIA 130 METALICE

p.61 BOBINE
PENTRU DISTRIBUTOARE

p.64 DISTRIBUTOARE MAMUR
SERIA 130

p.64 DISTRIBUTOARE CU MANETA
SERIA 130

p.64 PEDALE PNEUMATICE SI ELECTRICE
SERIA 140

p.65 BLOC DE DISTRIBUTOARE
SERIA 150

p.66 INSULE DE DISTRIBUTOARE
SERIA 160



DISTRIBUITOARE

SERIA 100

MV	AU4	15	3	PU	ML	NC	P
PRODUS							MATERIAL
MV - MINIDISTRIBUITOARE SERIA 100							PLASTIC - P
CONEXIUNI							OPTIUNI
AU4 = RACORD AUTOMAT AU ø4mm CUPLE PUSH-IN							NORMAL INCHIS - NC NORMAL DESCHIS - NO
AL4 = RACORD AUTOMAT ø4mm CU CUPLE PUSH-IN IN LATERAL							REVENIRE
M5 = M5							ARC - ML
ML5 = M5 LATERAL							OPERATIUNI
DIMENSIUNI							TIJA DE IMPINGERE - PU TIJA DE IMPINGERE - PP MANETA - LT MANETA ROTATIVA UNIDIRECTIONALA - RU MONTAJ PE PANOU - PB
15 = 15 mm							
FUNCTII							
2 = 2/2							
3 = 3/2							

MINI DISTRIBUITOARE 2/2, CONEXIUNE M5

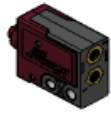

COD	REFERINTE
TH1000412001	MV M5 15 2 PU ML NC P
TH1000412002	MV M5 15 2 RL ML NC P
TH1000412003	MV M5 15 2 RU ML NC P
TH1000412004	MV M5 15 2 PP ML NC P
TH1000412005	MV M5 15 2 PB ML NC P
TH1000412006	MV M5 15 2 LT ML NC P
TH1000412101	MV ML5 15 2 PU ML NC P (conexiuni in lateral)
TH1000412102	MV ML5 15 2 RL ML NC P (conexiuni in lateral)
TH1000412103	MV ML5 15 2 RU ML NC P (conexiuni in lateral)
TH1000412104	MV ML5 15 2 PP ML NC P (conexiuni in lateral)
TH1000412105	MV ML5 15 2 PB ML NC P (conexiuni in lateral)
TH1000412106	MV ML5 15 2 LT ML NC P (conexiuni in lateral)

MINI DISTRIBUITOARE 2/2, CUPLE PUSH-IN



COD	REFERINTE
TH1000492001	MV AU4 15 2 PU ML NC P
TH1000492002	MV AU4 15 2 RL ML NC P
TH1000492003	MV AU4 15 2 RU ML NC P
TH1000492004	MV AU4 15 2 PP ML NC P
TH1000492005	MV AU4 15 2 PB ML NC P
TH1000492006	MV AU4 15 2 LT ML NC P
TH1000492101	MV AL4 15 2 PU ML NC P (conexiuni in lateral)
TH1000492102	MV AL4 15 2 RL ML NC P (conexiuni in lateral)
TH1000492103	MV AL4 15 2 RU ML NC P (conexiuni in lateral)
TH1000492104	MV AL4 15 2 PP ML NC P (conexiuni in lateral)
TH1000492105	MV AL4 15 2 PB ML NC P (conexiuni in lateral)
TH1000492106	MV AL4 15 2 LT ML NC P (conexiuni in lateral)

MINI DISTRIBUITOARE 3/2 CU BUTON SI CUPLE PUSH-IN



COD	REFERINTE
TH1000493001	MV AU4 15 3 PU ML NC P
TH1000493002	MV AU4 15 3 PU ML NO P
TH1000493003	MV AU4 15 3 RL ML NC P
TH1000493004	MV AU4 15 3 RL ML NO P
TH1000493005	MV AU4 15 3 RU ML NC P
TH1000493006	MV AU4 15 3 RU ML NO P
TH1000493007	MV AU4 15 3 PP ML NC P
TH1000493008	MV AU4 15 3 PP ML NO P
TH1000493009	MV AU4 15 3 PB ML NC P
TH1000493010	MV AU4 15 3 PB ML NO P
TH1000493011	MV AU4 15 3 LT ML NC P
TH1000493012	MV AU4 15 3 LT ML NO P
TH1000493101	MV AL4 15 3 PU ML NC P (conexiuni in lateral)
TH1000493102	MV AL4 15 3 PU ML NO P (conexiuni in lateral)
TH1000493103	MV AL4 15 3 RL ML NC P (conexiuni in lateral)
TH1000493104	MV AL4 15 3 RL ML NO P (conexiuni in lateral)
TH1000493105	MV AL4 15 3 RU ML NC P (conexiuni in lateral)
TH1000493106	MV AL4 15 3 RU ML NO P (conexiuni in lateral)
TH1000493107	MV AL4 15 3 PP ML NC P (conexiuni in lateral)
TH1000493108	MV AL4 15 3 PP ML NO P (conexiuni in lateral)
TH1000493109	MV AL4 15 3 PB ML NC P (conexiuni in lateral)
TH1000493110	MV AL4 15 3 PB ML NO P (conexiuni in lateral)
TH1000493111	MV AL4 15 3 LT ML NC P (conexiuni in lateral)
TH1000493112	MV AL4 15 3 LT ML NO P (conexiuni in lateral)

MINI DISTRIBUITOARE 3/2, CONEXIUNE M5

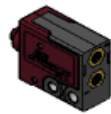

COD	REFERINTE
TH1000413001	MV M5 15 3 PU ML NC P
TH1000413002	MV M5 15 3 PU ML NO P
TH1000413003	MV M5 15 3 RL ML NC P
TH1000413004	MV M5 15 3 RL ML NO P
TH1000413005	MV M5 15 3 RU ML NC P
TH1000413006	MV M5 15 3 RU ML NO P
TH1000413007	MV M5 15 3 PP ML NC P
TH1000413008	MV M5 15 3 PP ML NO P
TH1000413009	MV M5 15 3 PB ML NC P
TH1000413010	MV M5 15 3 PB ML NO P
TH1000413011	MV M5 15 3 LT ML NC P
TH1000413012	MV M5 15 3 LT ML NO P
TH1000413101	MV ML5 15 3 PU ML NC P (conexiuni in lateral)
TH1000413102	MV ML5 15 3 PU ML NO P (conexiuni in lateral)
TH1000413103	MV ML5 15 3 RL ML NC P (conexiuni in lateral)
TH1000413104	MV ML5 15 3 RL ML NO P (conexiuni in lateral)
TH1000413105	MV ML5 15 3 RU ML NC P (conexiuni in lateral)
TH1000413106	MV ML5 15 3 RU ML NO P (conexiuni in lateral)
TH1000413107	MV ML5 15 3 PP ML NC P (conexiuni in lateral)
TH1000413108	MV ML5 15 3 PP ML NO P (conexiuni in lateral)
TH1000413109	MV ML5 15 3 PB ML NC P (conexiuni in lateral)
TH1000413110	MV ML5 15 3 PB ML NO P (conexiuni in lateral)
TH1000413111	MV ML5 15 3 LT ML NC P (conexiuni in lateral)
TH1000413112	MV ML5 15 3 LT ML NO P (conexiuni in lateral)

MINI DISTRIBUITOARE 3/2 CU BUTON (ingropat) SI CUPLE PUSH-IN



COD	REFERINTE
TH100C490001	MV AU4 15 3 PB ML NC P RT010 ACTIONARE CU BUTON
TH100C490002	MV AU4 15 3 PB ML NC P RT010 ACTIONARE CU BUTON
TH100C490003	MV AU4 15 3 PB ML NO P RT010 ACTIONARE CU BUTON
TH100C490004	MV AU4 15 3 PB ML NO P RT010 ACTIONARE CU BUTON
TH100C490005	MV AL4 15 3 PB ML NC P (conexiuni in lateral) RT010 ACTIONARE CU BUTON
TH100C490006	MV AL4 15 3 PB ML NC P (conexiuni in lateral) RT010 ACTIONARE CU BUTON
TH100C490007	MV AL4 15 3 PB ML NO P (conexiuni in lateral) RT010 ACTIONARE CU BUTON
TH100C490008	MV AL4 15 3 PB ML NO P (conexiuni in lateral) RT010 ACTIONARE CU BUTON

DISTRIBUITOARE

SERIA 100

MINI DISTRIBUITOR AU4-SELECTOR CU MANETA , 2 POZITII



COD	REFERINTE
TH100C490009	MV AU4 15 3 PB ML NC P RT300N SELECTOR (2 pozitii fixe)
TH100C490010	MV AU4 15 3 PB ML NO P RT300N SELECTOR (2 pozitii fixe)

MINI DISTRIBUITOARE AL4 + MANETA CU 2 POZITII

COD	REFERINTE
TH100C490011	MV AL4 15 3 PB ML NC P (conexiuni in lateral) RT300N SELECTOR (2 pozitii fixe)
TH100C490012	MV AL4 15 3 PB ML NO P (conexiuni in lateral) RT300N SELECTOR (2 pozitii fixe)

MINI DISTRIBUITOARE AU4 + PUSH BUTON



COD	REFERINTE
TH100C490013	MV AU4 15 3 PB ML NC P RT050R BUTON
TH100C490014	MV AU4 15 3 PB ML NO P RT050R BUTON

MINI DISTRIBUITOARE AL4 + PUSH BUTON

COD	REFERINTE
TH100C490015	MV AL4 15 3 PB ML NC P (conexiuni in lateral) RT050R BUTON
TH100C490016	MV AL4 15 3 PB ML NO P (conexiuni in lateral) RT050R BUTON

PANOU ACTUATORI

SELECTOR CU CHEIE



COD	REFERINTE
TH1003A00031	RT201N SELECTOR (2 pozitii fixe)

SELECTOR CU MANETA ROTATIVA SCURTA



COD	REFERINTE
TH1003A00032	RT300N SELECTOR (2 pozitii fixe)
TH1003A00033	RT350N SELECTOR (2 pozitii, cu retur)
TH1003A00034	RT313N SELECTOR (3 pozitii fixe)
TH1003A00035	RT383N SELECTOR (3 pozitii. Cu intoarcere pe centru)

SELECTOR CU MANETA ROTATIVA LUNGA



COD	REFERINTE
TH1003A00036	RT400N SELECTOR (2 pozitii fixe)
TH1003A00037	RT450N SELECTOR (2 pozitii, cu retur)
TH1003A00038	RT413N SELECTOR (3 pozitii fixe)
TH1003A00039	RT483N SELECTOR (3 pozitii. Cu intoarcere pe centru)

BUTON (ingropat)



COD	REFERINTE
TH1003A00040	RT010 CU BUTON
TH1003A00019	ALBASTRU
TH1003A00020	GALBEN
TH1003A00021	VERDE
TH1003A00047	ALB
TH1003A00048	NEGRU
TH1003A00049	ROSU

PUSH BUTON 40mm



COD	REFERINTE
TH1003A00041	RT050R BUTON
TH1003A00042	RT050N BUTON

PUSH BUTON LUNG 40mm



COD	REFERINTE
TH1003A00052	RT065R - 40 BUTON

PUSH BUTON EXTINS 60mm



COD	REFERINTE
TH1003A00057	RT065R - 60 BUTON

MANETA MULTIDIRECTIONALA



COD	REFERINTE
TH1003A00046	RT054R MANETA

EP110		1/8	3	NC	SN	00	C	
PRODUS							COMENZI	
EP110 - MINIDISTRIBUITOARE CU ACTIVARE ELECTRONICA							MANUAL - C AUTOMAT - N	
CONEXIUNI							ALIMENTARE	
1/8 = G1/8"							STANGA - SX DREAPTA - DX BIDIRECTIONAL - 00	
AU4 = RACORD AUTOMAT AU ø4mm CUPLE PUSH-IN							CONFIGURATII	
FUNCTII							ACTIONARE ELECTRICA - SN UNITATE INTERMEDIARA - MI UNITATE DE INTRARE - ME UNITATE DE IESIRE - MU	
3 = 3/2 2 = 2/2								
TIP								
NC = NORMAL INCHIS NO = NORMAL DESCHIS								

PANOU ACTUATORI

CONTACT ELECTRIC



COD	REFERINTE
TH1003A00050	NC CONTACT ELECTRIC
TH1003A00051	NO CONTACT ELECTRIC

DISTRIBUITOARE

SERIA 110

DISTRIBUITOR 3/2 ,G1/8



COD	REFERINTE
TH1103023001	EP110 1/8 3 NC SN SX C
TH1103023002	EP110 1/8 3 NC SN DX C
TH1103023003	EP110 1/8 3 NC SN OO C
TH1103023004	EP110 1/8 3 NO SN SX C
TH1103023005	EP110 1/8 3 NO SN DX C
TH1103023006	EP110 1/8 3 NO SN OO C

DISTRIBUITOR 3/2 , AU4



COD	REFERINTE
TH1103093001	EP110 AU4 3 NC SN SX C
TH1103093002	EP110 AU4 3 NC SN DX C
TH1103093003	EP110 AU4 3 NC SN OO C
TH1103093004	EP110 AU4 3 NO SN SX C
TH1103093005	EP110 AU4 3 NO SN DX C
TH1103093006	EP110 AU4 3 NO SN OO C

DISTRIBUITOR INTERMEDIAR 3/2,G1/8



COD	REFERINTE
TH1103023009	EP110 1/8 3 NC ME SX C
TH1103023013	EP110 1/8 3 NC MU SX C
TH1103023010	EP110 1/8 3 NO ME SX C
TH1103023014	EP110 1/8 3 NO MU SX C
TH1103023007	EP110 1/8 3 NC MI OO C
TH1103023008	EP110 1/8 3 NO MI OO C
TH1103023011	EP110 1/8 3 NC ME DX C
TH1103023015	EP110 1/8 3 NC MU DX C
TH1103023012	EP110 1/8 3 NO ME DX C
TH1103023016	EP110 1/8 3 NO MU DX C

DISTRIBUITOR INTERMEDIAR 3/2, AU4



COD	REFERINTE
TH1103093009	EP110 AU4 3 NC ME SX C
TH1103093013	EP110 AU4 3 NC MU SX C
TH1103093010	EP110 AU4 3 NO ME SX C
TH1103093014	EP110 AU4 3 NO MU SX C
TH1103093007	EP110 AU4 3 NC MI OO C
TH1103093008	EP110 AU4 3 NO MI OO C
TH1103093011	EP110 AU4 3 NC ME DX C
TH1103093015	EP110 AU4 3 NC MU DX C
TH1103093012	EP110 AU4 3 NO ME DX C
TH1103093016	EP110 AU4 3 NO MU DX C
TH1130C00001	KIT DE REPARATII
TH1130C00002	KIT REPARATII(PRESIUNE DIFERENTIALA)

DISTRIBUITOR 2/2,G1/8



COD	REFERINTE
TH1103022001	EP110 1/8 2 NC SN SX C
TH1103022002	EP110 1/8 2 NC SN DX C
TH1103022003	EP110 1/8 2 NC SN OO C
TH1103022004	EP110 1/8 2 NO SN SX C
TH1103022005	EP110 1/8 2 NO SN DX C
TH1103022006	EP110 1/8 2 NO SN OO C

DISTRIBUITOR 2/2, AU4



COD	REFERINTE
TH1103092001	EP110 AU4 2 NC SN SX C
TH1103092002	EP110 AU4 2 NC SN DX C
TH1103092003	EP110 AU4 2 NC SN OO C
TH1103092004	EP110 AU4 2 NO SN SX C
TH1103092005	EP110 AU4 2 NO SN DX C
TH1103092006	EP110 AU4 2 NO SN OO C

DISTRIBUITOR INTERMEDIAR 2/2,G1/8



COD	REFERINTE
TH1103022009	EP 110 1/8 2NCMESXC
TH1103022013	EP 110 1/8 2NCMUSXC
TH1103022010	EP 110 1/8 2NCMESXC
TH1102023014	EP 110 1/8 2NCMUSXC
TH1103022007	EP 110 1/8 2NCMIOOC
TH1103022008	EP 110 1/8 2NOMIOOC
TH1103022011	EP 110 1/8 2NCMEDXC
TH1103022015	EP 110 1/8 2NCMUDXC
TH1103022012	EP 110 1/8 2NOMEDXC
TH1103022016	EP 110 1/8 2NOMUDXC

DISTRIBUITOR INTERMEDIAR 2/2, AU4



COD	REFERINTE
TH1103092009	EP110 AU4 2 NC ME SX C
TH1103092013	EP110 AU4 2 NC MU SX C
TH1103092010	EP110 AU4 2 NO ME SX C
TH1103092014	EP110 AU4 2 NO MU SX C
TH1103092007	EP110 AU4 2 NC MI OO C
TH1103092008	EP110 AU4 2 NO MI OO C
TH1103092011	EP110 AU4 2 NC ME DX C
TH1103092015	EP110 AU4 2 NC MU DX C
TH1103092012	EP110 AU4 2 NO ME DX C
TH1103092016	EP110 AU4 2 NO MU DX C
TH1130C00001	KIT DE REPARATII
TH1130C00002	KIT DE REPARATII(PRESIUNE DIFERENTIALA)

KIT DE REPARATII CU SINA 35mm



COD	REFERINTE
TH1130C00003	KIT DE REPARATII

PIULITA DE FIXARE

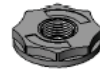

COD	REFERINTE
TH1311A00015	PIULITA DE FIXARE

BOBINA 22mm



COD	REFERINTE
THA502600018	DC12V BOBINA
THA502600006	DC24V BOBINA
THA502600007	AC24V BOBINA 50/60Hz
THA502600008	AC110V BOBINA 50/60Hz
THA502600009	AC220V BOBINA 50/60Hz

CONECTOR



COD	REFERINTE
THA502600010	CONECTOR SP. 22mm

DISTRIBUITOARE

SERIA 115

EVR	1/8"	18	5	SL	PM	00	M
PRODUS EVR - DISTRIBUITOARE - actiunare electrica VPR - DISTRIBUITOARE PNEUMATICE - actiunare pneumatica							MATERIAL METAL - M
CONEXIUNI 1/8" = G1/8"							OPTIUNI CENTRU INCHIS - CC CENTRU DESCHIS - CA PRESIUNEA IN CENTRU - CP 5/2 - 00
DIMENSIUNI 18 = 18 mm							REVENIRE ARC - ML PILOTATA - PM BISTABIL - BS REVENIRE IN CENTRU - RC
FUNCTII 5 = 5/2 6 = 5/3							
OPERATIUNI PN - PNEUMATIC SL - ELECTROPNEUMATIC SA - ELECTROPNEUMATIC ASISTAT							

DISTRIBUITOR CU ACTIONARE ELECTRICA EVR, G1/8-18mm

COD	REFERINTE
TH1151125101	EVR 1/8 18 5 SL PM OO M 12DC
TH1151125201	EVR 1/8 18 5 SL PM OO M 24DC
TH1151125601	EVR 1/8 18 5 SL PM OO M 24AC
TH1151125701	EVR 1/8 18 5 SL PM OO M 110AC
TH1151125801	EVR 1/8 18 5 SL PM OO M 220AC
TH1151125103	EVR 1/8 18 5 SA PM OO M 12DC
TH1151125203	EVR 1/8 18 5 SA PM OO M 24DC
TH1151125603	EVR 1/8 18 5 SA PM OO M 24AC
TH1151125703	EVR 1/8 18 5 SA PM OO M 110AC
TH1151125803	EVR 1/8 18 5 SA PM OO M 220AC
TH1151125102	EVR 1/8 18 5 SL BS OO M 12DC
TH1151125202	EVR 1/8 18 5 SL BS OO M 24DC
TH1151125602	EVR 1/8 18 5 SL BS OO M 24AC
TH1151125702	EVR 1/8 18 5 SL BS OO M 110AC
TH1151125802	EVR 1/8 18 5 SL BS OO M 220AC
TH1151125104	EVR 1/8 18 5 SA BS OO M 12DC
TH1151125204	EVR 1/8 18 5 SA BS OO M 24DC
TH1151125604	EVR 1/8 18 5 SA BS OO M 24AC
TH1151125704	EVR 1/8 18 5 SA BS OO M 110AC
TH1151125804	EVR 1/8 18 5 SA BS OO M 220AC
TH1151126101	EVR 1/8 18 6 SL RC CC M 12DC
TH1151126201	EVR 1/8 18 6 SL RC CC M 24DC
TH1151126601	EVR 1/8 18 6 SL RC CC M 24AC
TH1151126701	EVR 1/8 18 6 SL RC CC M 110AC
TH1151126801	EVR 1/8 18 6 SL RC CC M 220AC
TH1151126102	EVR 1/8 18 6 SL RC CA M 12DC
TH1151126202	EVR 1/8 18 6 SL RC CA M 24DC
TH1151126602	EVR 1/8 18 6 SL RC CA M 24AC
TH1151126702	EVR 1/8 18 6 SL RC CA M 110AC
TH1151126802	EVR 1/8 18 6 SL RC CA M 220AC
TH1151126103	EVR 1/8 18 6 SL RC CP M 12DC
TH1151126203	EVR 1/8 18 6 SL RC CP M 24DC
TH1151126603	EVR 1/8 18 6 SL RC CP M 24AC
TH1151126703	EVR 1/8 18 6 SL RC CP M 110AC
TH1151126803	EVR 1/8 18 6 SL RC CP M 220AC
TH1151126104	EVR 1/8 18 6 SA RC CC M 12DC
TH1151126204	EVR 1/8 18 6 SA RC CC M 24DC
TH1151126604	EVR 1/8 18 6 SA RC CC M 24AC
TH1151126704	EVR 1/8 18 6 SA RC CC M 110AC
TH1151126804	EVR 1/8 18 6 SA RC CC M 220AC
TH1151126105	EVR 1/8 18 6 SA RC CA M 12DC
TH1151126205	EVR 1/8 18 6 SA RC CA M 24DC
TH1151126605	EVR 1/8 18 6 SA RC CA M 24AC
TH1151126705	EVR 1/8 18 6 SA RC CA M 110AC
TH1151126805	EVR 1/8 18 6 SA RC CA M 220AC
TH1151126106	EVR 1/8 18 6 SA RC CP M 12DC
TH1151126206	EVR 1/8 18 6 SA RC CP M 24DC
TH1151126606	EVR 1/8 18 6 SA RC CP M 24AC
TH1151126706	EVR 1/8 18 6 SA RC CP M 110AC
TH1151126806	EVR 1/8 18 6 SA RC CP M 220AC



DISTRIBUITOR CU ACTIONARE PNEUMATICA VPR, G1/8-18mm

COD	REFERINTE
TH1151225001	VPR 1/8 18 5 PN PM OO M
TH1151225002	VPR 1/8 18 5 PN BS OO M
TH1151226001	VPR 1/8 18 6 PN RC CC M
TH1151226002	VPR 1/8 18 6 PN RC CA M
TH1151226003	VPR 1/8 18 6 PN RC CP M



PLACA DE BAZA PENTRU DISTRIBUITOR 115-G1/8

COD	REFERINTE
TH1115C00002	PLACA DE BAZA - 2 DISTRIBUITOARE
TH1115C00003	PLACA DE BAZA - 3 DISTRIBUITOARE
TH1115C00004	PLACA DE BAZA - 4 DISTRIBUITOARE
TH1115C00005	PLACA DE BAZA - 5 DISTRIBUITOARE
TH1115C00006	PLACA DE BAZA - 6 DISTRIBUITOARE
TH1115C00007	PLACA DE BAZA - 7 DISTRIBUITOARE
TH1115C00008	PLACA DE BAZA - 8 DISTRIBUITOARE
TH1115C00009	PLACA DE BAZA - 9 DISTRIBUITOARE
TH1115C00010	PLACA DE BAZA - 10 DISTRIBUITOARE
TH1315A00013	KIT PENTRU PLACA DE BAZA



BOBINA PENTRU DISTRIBUITOR 115-G1/8

COD	REFERINTE
TH1110C00001	3/2 NC 12V DC
TH1110C00002	3/2 NC 24V DC
TH1110C00003	3/2 NC 24V AC
TH1110C00004	3/2 NC 110V AC
TH1110C00005	3/2 NC 220V AC



CONECTOR STANDARD 15mm

COD	REFERINTE
THA502600014	conector 15mm



CONECTOR CU LED 15mm

COD	REFERINTE
THA502600020	15MM 24V conector cu led
THA502600021	15MM 115V conector cu led
THA502600022	15MM 230V conector cu led



CONECTOR CU CABLU SI LED

COD	REFERINTE
THA502600023	15MM 24V conector cu cablu si led
THA502600024	15MM 115V conector cu cablu si led
THA502600025	15MM 230V conector cu cablu si led



ME	1/8"	22	3	PU	ML	NC	P	
PRODUS							MATERIAL	
EV - DISTRIBUITOARE - actionare electrica							PLASTIC - P	
ME - DISTRIBUITOARE - actionare mecanica								
VM - DISTRIBUITOARE - actionare manuala								
VP - DISTRIBUITOARE - actionare pneumatica								
CONEXIUNI							OPTIUNI	
1/8" = G1/8"							NORMAL INCHIS - NC	
							NORMAL DESCHIS - NO	
							CENTRU INCHIS - CC	
							CENTRU DESCHIS - CA	
							PRESIUNEA IN CENTRU - CP	
							5/2 - 00	
DIMENSIUNI							REVENIRE	
22 = 22 mm							ARC - ML	
FUNCTII							PILOTAT - PM	
3 = 3/2							BISTABIL - BS	
5 = 5/2							ACTIONAT IN 3 POZITII - ST	
6 = 5/3							CENTRAT - RC	
FUNCTIONARE							ARC PNEUMATIC - MP	
PU - BUTON							DIFERENTIAL - DF	
PP - BUTON EXTINS								
LT - PARGHIE								
RL - PARGHIE CU ROLA								
RU - PARGHIE CU ROLA UNISENS								
PB - MONTAJ PE PANOU								
PS - BUTON								
PO - BUTON INGROPAT								
LS - PARGHIE INCLINATA								
RS - PARGHIE CU ROLA SERVOPILOTATA								
RO - PARGHIE CU ROLA UNISENS PILOTATA								
AN - ANTENA								
TA - MANETA BASCULANTA								
TS - MANETA TRAGERE (PUSH-PULL)								
LV - PARGHIE AXIALA								
L9 - PARGHIE LA 90°								
PN - DISTRIBUTOR CU ACTIONARE PNEUMATICA								
SL - DISTRIBUTOR CU ACTIONARE ELECTRICA SI PNEUMATICA								
SA - DISTRIBUTOR CU ACTIONARE ELECTRICA SI PNEUMATICA CU CONEXIUNE MS								
AU - DISTRIBUTOR CU ACTIONARE ELECTRICA SI PNEUMATICA CU CUPLE PUSH-IN								
RCC - PARGHIE CU ROLA CU RULMENTI								
RUC - PARGHIE CU ROLA UNISENS CU RULMENTI								

DISTRIBUITOARE" EV" - ACTIONARE ELECTRICA, G=1/8



COD	REFERINTE
TH1202123001	EV 1/8" 22 3 SL PM NC P
TH1202123002	EV 1/8" 22 3 SL PM NO P
TH1202123003	EV 1/8" 22 3 SL BS OO P
TH1202123004	EV 1/8" 22 3 SA PM NC P
TH1202123005	EV 1/8" 22 3 SA PM NO P
TH1202123006	EV 1/8" 22 3 SA BS OO P
TH1202123007	EV 1/8" 22 3 AU PM NC P
TH1202123008	EV 1/8" 22 3 AU PM NO P
TH1202123009	EV 1/8" 22 3 AU BS OO P
TH1202125001	EV 1/8" 22 5 SL PM OO P
TH1202125002	EV 1/8" 22 5 SL BS OO P
TH1202125003	EV 1/8" 22 5 SA PM OO P
TH1202125004	EV 1/8" 22 5 SA BS OO P
TH1202125005	EV 1/8" 22 5 AU PM OO P
TH1202125006	EV 1/8" 22 5 AU BS OO P
TH1202126001	EV 1/8" 22 6 SL RC CC P
TH1202126002	EV 1/8" 22 6 SL RC CA P
TH1202126003	EV 1/8" 22 6 SL RC CP P
TH1202126004	EV 1/8" 22 6 SA RC CC P
TH1202126005	EV 1/8" 22 6 SA RC CA P
TH1202126006	EV 1/8" 22 6 SA RC CP P
TH1202126007	EV 1/8" 22 6 AU RC CC P
TH1202126008	EV 1/8" 22 6 AU RC CA P
TH1202126009	EV 1/8" 22 6 AU RC CP P

DISTRIBUITOARE" EV" - CU BOBINE, ACTIONARE ELECTRICA, G=1/8



COD	REFERINTE
TH1202123201	EV 1/8" 22 3 SL PM NC P 24V DC
TH1202123601	EV 1/8" 22 3 SL PM NC P 24V AC
TH1202123701	EV 1/8" 22 3 SL PM NC P 110V DC
TH1202123801	EV 1/8" 22 3 SL PM NC P 220V DC
TH1202125201	EV 1/8" 22 5 SL PM OO P 24V DC
TH1202125601	EV 1/8" 22 5 SL PM OO P 24V AC
TH1202125701	EV 1/8" 22 5 SL PM OO P 110V DC
TH1202125801	EV 1/8" 22 5 SL PM OO P 220V DC
TH1202125202	EV 1/8" 22 5 SL BS OO P 24V DC
TH1202125602	EV 1/8" 22 5 SL BS OO P 24V AC
TH1202125702	EV 1/8" 22 5 SL BS OO P 110V DC
TH1202125802	EV 1/8" 22 5 SL BS OO P 220V DC
TH1202126201	EV 1/8" 22 6 SL RC CC P 24V DC
TH1202126601	EV 1/8" 22 6 SL RC CC P 24V AC
TH1202126701	EV 1/8" 22 6 SL RC CC P 110V DC
TH1202126801	EV 1/8" 22 6 SL RC CC P 220V DC

DISTRIBUITOARE "VP" - ACTIONARE CU MANETA, G=1/8



COD	REFERINTE
TH1202223001	VP 1/8" 22 3 PN PM NC P
TH1202223002	VP 1/8" 22 3 PN PM NO P
TH1202223003	VP 1/8" 22 3 PN BS OO P
TH1202223004	VP 1/8" 22 3 PN DF OO P
TH1202225001	VP 1/8" 22 5 PN PM OO P
TH1202225002	VP 1/8" 22 5 PN BS OO P
TH1202225003	VP 1/8" 22 5 PN DF OO P
TH1202226001	VP 1/8" 22 6 PN RC CC P
TH1202226002	VP 1/8" 22 6 PN RC CA P
TH1202226003	VP 1/8" 22 6 PN RC CP P

DISTRIBUITOARE "VM" - ACTIONARE PNEUMATICA, G=1/8

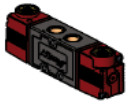

COD	REFERINTE
TH1202323001	VM 1/8" 22 3 TA ML NC P
TH1202323002	VM 1/8" 22 3 TA BS OO P
TH1202323004	VM 1/8" 22 3 LV ML NC P
TH1202323005	VM 1/8" 22 3 LV BS OO P
TH1202323006	VM 1/8" 22 3 L9 ML NC P
TH1202323007	VM 1/8" 22 3 L9 BS OO P
TH1202325001	VM 1/8" 22 5 TA ML OO P
TH1202325002	VM 1/8" 22 5 TA BS OO P
TH1202325003	VM 1/8" 22 5 LV ML OO P
TH1202325004	VM 1/8" 22 5 LV BS OO P
TH1202325005	VM 1/8" 22 5 L9 ML OO P
TH1202325006	VM 1/8" 22 5 L9 BS OO P
TH1202326001	VM 1/8" 22 6 LV ST CC P
TH1202326002	VM 1/8" 22 6 LV ST CA P
TH1202326003	VM 1/8" 22 6 LV ST CP P
TH1202326004	VM 1/8" 22 6 LV RC CC P
TH1202326005	VM 1/8" 22 6 LV RC CA P
TH1202326006	VM 1/8" 22 6 LV RC CP P
TH1202326007	VM 1/8" 22 6 L9 ST CC P
TH1202326008	VM 1/8" 22 6 L9 ST CA P
TH1202326009	VM 1/8" 22 6 L9 ST CP P
TH1202326010	VM 1/8" 22 6 L9 RC CC P
TH1202326011	VM 1/8" 22 6 L9 RC CA P
TH1202326012	VM 1/8" 22 6 L9 RC CP P
TH1202326013	VM 1/8" 22 6 TA RC CC P
TH1202326014	VM 1/8" 22 6 TA RC CA P
TH1202326015	VM 1/8" 22 6 TA RC CP P

DISTRIBUITOARE

SERIA 120

DISTRIBUITOARE "ME" - ACTIONARE MECANICA, G=1/8

COD	REFERINTE
TH1202423001	ME 1/8" 22 3 PU ML NC P
TH1202423002	ME 1/8" 22 3 PU ML NO P
TH1202423003	ME 1/8" 22 3 RL ML NC P
TH1202423004	ME 1/8" 22 3 RL ML NO P
TH1202423005	ME 1/8" 22 3 RU ML NC P
TH1202423006	ME 1/8" 22 3 RU ML NO P
TH1202425001	ME 1/8" 22 5 PU ML OO P
TH1202425002	ME 1/8" 22 5 RL ML OO P
TH1202425003	ME 1/8" 22 5 RU ML OO P
TH1202523001	ME 1/8" 22 3 PS PM NC P
TH1202523002	ME 1/8" 22 3 PS PM NO P
TH1202523003	ME 1/8" 22 3 RS PM NC P
TH1202523004	ME 1/8" 22 3 RS PM NO P
TH1202523005	ME 1/8" 22 3 RO PM NC P
TH1202523006	ME 1/8" 22 3 RO PM NO P
TH1202523007	ME 1/8" 22 3 PO PM NC P
TH1202523008	ME 1/8" 22 3 PO PM NO P
TH1202523009	ME 1/8" 22 3 PB PM NC P
TH1202523010	ME 1/8" 22 3 PB PM NO P
TH1202523011	ME 1/8" 22 3 LS PM NC P
TH1202523012	ME 1/8" 22 3 LS PM NO P
TH1202523013	ME 1/8" 22 3 AN PM NC P
TH1202523014	ME 1/8" 22 3 AN PM NO P
TH1202525001	ME 1/8" 22 5 PS PM OO P
TH1202525002	ME 1/8" 22 5 RS PM OO P
TH1202525003	ME 1/8" 22 5 RO PM OO P
TH1202525004	ME 1/8" 22 5 PO PM OO P
TH1202525005	ME 1/8" 22 5 PB PM OO P
TH1202525006	ME 1/8" 22 5 LS PM OO P
TH1202525007	ME 1/8" 22 5 AN PM OO P

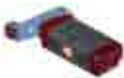

PLACA DE BAZA (bloc ramificator) PENTRU DISTRIBUITOARE G=1/8

COD	REFERINTE
TH1226C00012	placa de baza-pt.2 distribuitoare
TH1226C00013	placa de baza-pt.3 distribuitoare
TH1226C00014	placa de baza-pt.4 distribuitoare
TH1226C00015	placa de baza-pt.5 distribuitoare
TH1226C00016	placa de baza-pt.6 distribuitoare
TH1226C00017	placa de baza -pt.7 distribuitoare
TH1226C00018	placa de baza-pt.8 distribuitoare
TH1226C00019	Suport lung pt.distribuitoare
TH1226C00020	suport scurt pt.distribuitoare



BOBINA 22mm

COD	REFERINTE
THA502600018	THA502600018
THA502600006	THA502600006
THA502600007	THA502600007
THA502600008	THA502600008
THA502600009	THA502600009



DISTRIBUITOARE "ME" 22mm - ACTIONARE MECANICA, G=1/8,CU RULMENTI CU BILE

COD	REFERINTE
TH1202423007	ME1/8 22 3 RLC ML NC P
TH1202423008	ME1/8 22 3 RLC ML NO P
TH1202423009	ME1/8 22 3 RUC ML NC P
TH1202423010	ME1/8 22 3 RUC ML NO P
TH1202425006	ME1/8 22 5 RLC ML OO P
TH1202425007	ME1/8 22 5 RUC ML OO P



CONECTOR

COD	REFERINTE
THA502600010	C.Sp. 22mm conector



CONECTOR CU LED 22mm

COD	REFERINTE
THA502600026	conector cu led 22 mm 24V
THA502600027	conector cu led 22mm 115V
THA502600028	conector cu led 22mm 230V



CONECTOR CU LED + CABLU 22mm

COD	REFERINTE
THA502600029	conector cu led+cablu 22mm 24V
THA502600030	conector cu led+cablu 22mm 115V
THA502600031	conector cu led +cablu 22mm 230V



MER	1/8"	22	5	PU	ML	NC	P	
PRODUS							MATERIAL	
EVR - DISTRIBUITOARE - actionare electrica							PLASTIC - P	
MER - DISTRIBUITOARE - actionare mecanica							METAL - M	
VMR - DISTRIBUITOARE - actionare manuala								
VPR - DISTRIBUITOARE - actionare pneumatica								
CONEXIUNI							OPTIUNI	
1/8" = G1/8"							NORMAL INCHIS - NC	
1/4" = G1/4"							NORMAL DESCHIS - NO	
AU8 = RACORD AUTOMAT AU 8							CENTRU INCHIS - CC	
							CENTRU DESCHIS - CA	
							PRESIUNEA IN CENTRU - CP	
							5/2 - 00	
DIMENSIUNI							REVENIRE	
22 = 22 mm							ARC - ML	
FUNCTII							PILOTAT - PM	
5 = 5/2							BISTABIL - BS	
6 = 5/3							ACTIONAT IN 3 POZITII - ST	
FUNCTIONARE							CENTRAT - RC	
PU - BUTON							ARC PNEUMATIC - MP	
PP - BUTON EXTINS							DIFERENTIAL - DF	
LT - PARGHIE								
RL - PARGHIE CU ROLA								
RU - PARGHIE CU ROLA UNISENS								
PB - MONTAJ PE PANOU								
PS - BUTON								
PO - BUTON INGROPAT								
LS - PARGHIE INCLINATA								
RS - PARGHIE CU ROLA SERVOPILOTATA								
RO - PARGHIE CU ROLA UNISENS PILOTATA								
AN - ANTENA								
TA - MANETA BASCULANTA								
TS - MANETA TRAGERE (PUSH-PULL)								
LV - PARGHIE AXIALA								
L9 - PARGHIE LA 90°								
PN - DISTRIBUTOR CU ACTIONARE PNEUMATICA								
SL - DISTRIBUTOR CU ACTIONARE ELECTRICA SI PNEUMATICA								
SA - DISTRIBUTOR CU ACTIONARE ELECTRICA SI PNEUMATICA CU CONEXIUNE M5								
AU - DISTRIBUTOR CU ACTIONARE ELECTRICA SI PNEUMATICA CU CUPLE PUSH-IN								

DISTRIBUITOARE

SERIA 125

DISTRIBUITORE "EVR"- ACTIONARE ELECTRICA, 22mm, G=1/8



COD	REFERINTE
TH1252125001	EVR 1/8" 22 5 SL PM OO P
TH1252125002	EVR 1/8" 22 5 SL BS OO P
TH1252125003	EVR 1/8" 22 5 SA ML OO P
TH1252125004	EVR 1/8" 22 5 SA BS OO P
TH1252126001	EVR 1/8" 22 6 SL RC CC P
TH1252126002	EVR 1/8" 22 6 SL RC CA P
TH1252126003	EVR 1/8" 22 6 SL RC CP P
TH1252126004	EVR 1/8" 22 6 SA RC CC P
TH1252126005	EVR 1/8" 22 6 SA RC CA P
TH1252126006	EVR 1/8" 22 6 SA RC CP P

DISTRIBUITOARE" EVR" CU BOBINE - ACTIONARE ELECTRICA,22mm,G=1/8



COD	REFERINTE
TH1252125201	EVR 1/8" 22 5 SL PM OO P 24V DC
TH1252125601	EVR 1/8" 22 5 SL PM OO P 24V AC
TH1252125701	EVR 1/8" 22 5 SL PM OO P 110V AC
TH1252125801	EVR 1/8" 22 5 SL PM OO P 220V AC
TH1252125202	EVR 1/8" 22 5 SL BS OO P 24V DC
TH1252125602	EVR 1/8" 22 5 SL BS OO P 24V AC
TH1252125702	EVR 1/8" 22 5 SL BS OO P 110V AC
TH1252125802	EVR 1/8" 22 5 SL BS OO P 220V AC
TH1252126201	EVR 1/8" 22 6 SL RC CC P 24V DC
TH1252126601	EVR 1/8" 22 6 SL RC CC P 24V AC
TH1252126701	EVR 1/8" 22 6 SL RC CC P 110V AC
TH1252126801	EVR 1/8" 22 6 SL RC CC P 220V AC

DISTRIBUITOARE 22mm - ACTIONARE ELECTRICA , G=1/4



COD	REFERINTE
TH1252135001	EVR 1/4" 22 5 SL PM OO P
TH1252135002	EVR 1/4" 22 5 SL BS OO P
TH1252135003	EVR 1/4" 22 5 SA ML OO P
TH1252135004	EVR 1/4" 22 5 SA BS OO P
TH1252136001	EVR 1/4" 22 6 SL RC CC P
TH1252136002	EVR 1/4" 22 6 SL RC CA P
TH1252136003	EVR 1/4" 22 6 SL RC CP P
TH1252136004	EVR 1/4" 22 6 SA RC CC P
TH1252136005	EVR 1/4" 22 6 SA RC CA P
TH1252136006	EVR 1/4" 22 6 SA RC CP P

DISTRIBUITOARE 22mm, BOBINE - ACTIONARE ELECTRICA, G=1/4



COD	REFERINTE
TH1252135201	EVR 1/4" 22 5 SL PM OO P 24V DC
TH1252135601	EVR 1/4" 22 5 SL PM OO P 24V AC
TH1252135701	EVR 1/4" 22 5 SL PM OO P 110V AC
TH1252135801	EVR 1/4" 22 5 SL PM OO P 220V AC
TH1252135202	EVR 1/4" 22 5 SL BS OO P 24V DC
TH1252135602	EVR 1/4" 22 5 SL BS OO P 24V AC
TH1252135702	EVR 1/4" 22 5 SL BS OO P 110V AC
TH1252135802	EVR 1/4" 22 5 SL BS OO P 220V AC
TH1252136201	EVR 1/4" 22 6 SL RC CC P 24V DC
TH1252136601	EVR 1/4" 22 6 SL RC CC P 24V AC
TH1252136701	EVR 1/4" 22 6 SL RC CC P 110V AC
TH1252136801	EVR 1/4" 22 6 SL RC CC P 220V AC

DISTRIBUITOARE" EVR",AU8 - 22mm - ACTIONARE ELECTRICA - MONTAJ PE PLACA DE BAZA



COD	REFERINTE
TH1252195001	EVR AU8 22 5 SL PM OO P
TH1252195002	EVR AU8 22 5 SL BS OO P
TH1252195005	EVR AU8 22 5 AU ML OO P
TH1252195006	EVR AU8 22 5 AU BS OO P
TH1252196001	EVR AU8 22 6 SL RC CC P
TH1252196002	EVR AU8 22 6 SL RC CA P
TH1252196003	EVR AU8 22 6 SL RC CP P
TH1252196007	EVR AU8 22 6 AU RC CC P
TH1252196008	EVR AU8 22 6 AU RC CA P
TH1252196009	EVR AU8 22 6 AU RC CP P

DISTRIBUITOR "VPR" 22mm - ACTIONARE PNEUMATICA, G=1/8



COD	REFERINTE
TH1252225001	VPR 1/8" 22 5 PN PM OO P
TH1252225002	VPR 1/8" 22 5 PN BS OO P
TH1252225003	VPR 1/8" 22 5 PN DF OO P
TH1252226001	VPR 1/8" 22 6 PN RC CC P
TH1252226002	VPR 1/8" 22 6 PN RC CA P
TH1252226003	VPR 1/8" 22 6 PN RC CP P

DISTRIBUITOR "VPR" 22mm - ACTIONARE PNEUMATICA, G=1/4



COD	REFERINTE
TH1252235001	VPR 1/4" 22 5 PN PM OO P
TH1252235002	VPR 1/4" 22 5 PN BS OO P
TH1252235003	VPR 1/4" 22 5 PN DF OO P
TH1252236001	VPR 1/4" 22 6 PN RC CC P
TH1252236002	VPR 1/4" 22 6 PN RC CA P
TH1252236003	VPR 1/4" 22 6 PN RC CP P

DISTRIBUITOR" VPR", AU8-22mm - ACTIONARE PNEUMATICA - MONTAJ PE PLACA DE BAZA



COD	REFERINTE
TH1252295001	VPR AU8 22 5 PN PM OO P
TH1252295002	VPR AU8 22 5 PN BS OO P
TH1252295003	VPR AU8 22 5 PN DF OO P
TH1252296001	VPR AU8 22 6 PN RC CC P
TH1252296002	VPR AU8 22 6 PN RC CA P
TH1252296003	VPR AU8 22 6 PN RC CP P

DISTRIBUITOARE" MER", 22mm - ACTIONARE MECANICA, G=1/4



COD	REFERINTE
TH1252435001	MER 1/4" 22 5 PU ML OO P
TH1252435002	MER 1/4" 22 5 RL ML OO P
TH1252435003	MER 1/4" 22 5 RU ML OO P
TH1252535001	MER 1/4" 22 5 PS PM OO P
TH1252535002	MER 1/4" 22 5 RS PM OO P
TH1252535003	MER 1/4" 22 5 RO PM OO P
TH1252535004	MER 1/4" 22 5 PO PM OO P
TH1252535005	MER 1/4" 22 5 PB PM OO P
TH1252535006	MER 1/4" 22 5 LS PM OO P
TH1252535007	MER 1/4" 22 5 AN PM OO P

DISTRIBUITOR" VMR", 22mm - ACTIONATE CU MANETA, G=1/4



COD	REFERINTE
TH1252335001	VMR 1/4" 22 5 TA ML OO P
TH1252335002	VMR 1/4" 22 5 TA BS OO P
TH1252335003	VMR 1/4" 22 5 LV ML OO P
TH1252335004	VMR 1/4" 22 5 LV BS OO P
TH1252335005	VMR 1/4" 22 5 L9 ML OO P
TH1252335006	VMR 1/4" 22 5 L9 BS OO P
TH1252336001	VMR 1/4" 22 6 LV ST CC P
TH1252336002	VMR 1/4" 22 6 LV ST CA P
TH1252336003	VMR 1/4" 22 6 LV ST CP P
TH1252336004	VMR 1/4" 22 6 LV RC CC P
TH1252336005	VMR 1/4" 22 6 LV RC CA P
TH1252336006	VMR 1/4" 22 6 LV RC CP P
TH1252336007	VMR 1/4" 22 6 L9 ST CC P
TH1252336008	VMR 1/4" 22 6 L9 ST CA P
TH1252336009	VMR 1/4" 22 6 L9 ST CP P
TH1252336010	VMR 1/4" 22 6 L9 RC CC P
TH1252336011	VMR 1/4" 22 6 L9 RC CA P
TH1252336012	VMR 1/4" 22 6 L9 RC CP P
TH1252336013	VMR 1/4" 22 6 TA RC CC P
TH1252336014	VMR 1/4" 22 6 TA RC CA P
TH1252336015	VMR 1/4" 22 6 TA RC CP P

DISTRIBUITOARE "MER" 22mm - ACTIONARE MECANICA, G=1/4, CU RULMENTI CU BILE



COD	REFERINTE
TH1252435006	MER 1/4 22 RLC ML OO P
TH1252435007	MER 1/4 22 RUC ML OO P

DISTRIBUITOARE

SERIA 127

DISTRIBUITOARE "EVR", 22mm - ACTIONARE ELECTRICA, G=1/8



COD	REFERINTE
TH1272123001	EVR 1/8" 22 3 SL PM NC M
TH1272123002	EVR 1/8" 22 3 SL PM NO M
TH1272123003	EVR 1/8" 22 3 SL BS OO M
TH1272123004	EVR 1/8" 22 3 SA ML NC M
TH1272123005	EVR 1/8" 22 3 SA ML NO M
TH1272123006	EVR 1/8" 22 3 SA BS OO M
TH1272123007	EVR 1/8" 22 3 AU ML NC M
TH1272123008	EVR 1/8" 22 3 AU ML NO M
TH1272123009	EVR 1/8" 22 3 AU BS OO M
TH1272125001	EVR 1/8 22 5 SL PM OO M
TH1272125002	EVR 1/8 22 5 SL BS OO M
TH1272125003	EVR 1/8 22 5 SA ML OO M
TH1272125004	EVR 1/8 22 5 SA BS OO M
TH1272125005	EVR 1/8 22 5 AU ML OO M
TH1272125006	EVR 1/8 22 5 AU BS OO M
TH1272126001	EVR 1/8 22 6 SL RC CC M
TH1272126002	EVR 1/8 22 6 SL RC CA M
TH1272126003	EVR 1/8 22 6 SL RC CP M
TH1272126004	EVR 1/8 22 6 SA RC CC M
TH1272126005	EVR 1/8 22 6 SA RC CA M
TH1272126006	EVR 1/8 22 6 SA RC CP M
TH1272126007	EVR 1/8 22 6 AU RC CC M
TH1272126008	EVR 1/8 22 6 AU RC CA M
TH1272126009	EVR 1/8 22 6 AU RC CP M

DISTRIBUITOARE "EVR", 22mm CU BOBINE - ACTIONARE ELECTRICA, G=1/4



COD	REFERINTE
TH1272133201	EVR 1/4" 22 3 SL PM NC M 24V DC
TH1272133601	EVR 1/4" 22 3 SL PM NC M 24V AC
TH1272133701	EVR 1/4" 22 3 SL PM NC M 110V AC
TH1272133801	EVR 1/4" 22 3 SL PM NC M 220V AC
TH1272135201	EVR 1/4 22 5 SL PM OO M 24V DC
TH1272135601	EVR 1/4 22 5 SL PM OO M 24V AC
TH1272135701	EVR 1/4 22 5 SL PM OO M 110V AC
TH1272135801	EVR 1/4 22 5 SL PM OO M 220V AC
TH1272135202	EVR 1/4 22 5 SL BS OO M 24V DC
TH1272135602	EVR 1/4 22 5 SL BS OO M 24V AC
TH1272135702	EVR 1/4 22 5 SL BS OO M 110V AC
TH1272135802	EVR 1/4 22 5 SL BS OO M 220V AC
TH1272136201	EVR 1/4 22 6 SL RC CC M 24V DC
TH1272136601	EVR 1/4 22 6 SL RC CC M 24V AC
TH1272136701	EVR 1/4 22 6 SL RC CC M 110V AC
TH1272136801	EVR 1/4 22 6 SL RC CC M 220V AC

DISTRIBUITOARE "EVR" CU BOBINE - ACTIONARE ELECTRICA, G=1/8



COD	REFERINTE
TH1272123201	EVR 1/8" 22 3 SL PM NC M 24V DC
TH1272123601	EVR 1/8" 22 3 SL PM NC M 24V AC
TH1272123701	EVR 1/8" 22 3 SL PM NC M 110V AC
TH1272123801	EVR 1/8" 22 3 SL PM NC M 220V AC
TH1272125201	EVR 1/8 22 5 SL PM OO M 24V DC
TH1272125601	EVR 1/8 22 5 SL PM OO M 24V AC
TH1272125701	EVR 1/8 22 5 SL PM OO M 110V AC
TH1272125801	EVR 1/8 22 5 SL PM OO M 220V AC
TH1272125202	EVR 1/8 22 5 SL BS OO M 24V DC
TH1272125602	EVR 1/8 22 5 SL BS OO M 24V AC
TH1272125702	EVR 1/8 22 5 SL BS OO M 110V AC
TH1272125802	EVR 1/8 22 5 SL BS OO M 220V AC
TH1272126201	EVR 1/8 22 6 SL RC CC M 24V DC
TH1272126601	EVR 1/8 22 6 SL RC CC M 24V AC
TH1272126701	EVR 1/8 22 6 SL RC CC M 110V AC
TH1272126801	EVR 1/8 22 6 SL RC CC M 220V AC

DISTRIBUITOARE "EVR", 22mm - ACTIONARE ELECTRICA, G=1/4



COD	REFERINTE
TH1272133001	EVR 1/4 22 3 SL PM NC M
TH1272133002	EVR 1/4 22 3 SL PM NO M
TH1272133003	EVR 1/4 22 3 SL PM OO M
TH1272133004	EVR 1/4 22 3 SA ML NC M
TH1272133005	EVR 1/4 22 3 SA ML NO M
TH1272133006	EVR 1/4 22 3 SA BS OO M
TH1272133007	EVR 1/4 22 3 AU ML NC M
TH1272133008	EVR 1/4 22 3 AU ML NO M
TH1272133009	EVR 1/4 22 3 AU BS OO M
TH1272135001	EVR 1/4 22 5 SL PM OO M
TH1272135002	EVR 1/4 22 5 SL BS OO M
TH1272135003	EVR 1/4 22 5 SA ML OO M
TH1272135004	EVR 1/4 22 5 SA BS OO M
TH1272135005	EVR 1/4 22 5 AU PM OO M
TH1272135006	EVR 1/4 22 5 AU BS OO M
TH1272136001	EVR 1/4 22 6 SL RC CC M
TH1272136002	EVR 1/4 22 6 SL RC CA M
TH1272136003	EVR 1/4 22 6 SL RC CP M
TH1272136004	EVR 1/4 22 6 SA RC CC M
TH1272136005	EVR 1/4 22 6 SA RC CA M
TH1272136006	EVR 1/4 22 6 SA RC CP M
TH1272136007	EVR 1/4 22 6 AU RC CC M
TH1272136008	EVR 1/4 22 6 AU RC CA M
TH1272136009	EVR 1/4 22 6 AU RC CP M

DISTRIBUITOARE "VPR", 22mm - ACTIONARE PNEUMATICA, G=1/8

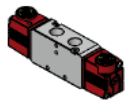

COD	REFERINTE
TH1272223001	VPR 1/8" 22 3 PN PM NC M
TH1272223002	VPR 1/8" 22 3 PN PM NO M
TH1272223003	VPR 1/8" 22 3 PN BS OO M
TH1272224004	VPR 1/8" 22 3 PN DF OO M
TH1272225001	VPR 1/8" 22 5 PN PM OO M
TH1272225002	VPR 1/8" 22 5 PN BS OO M
TH1272225003	VPR 1/8" 22 5 PN DF OO M
TH1272226001	VPR 1/8" 22 6 PN RC CC M
TH1272226002	VPR 1/8" 22 6 PN RC CA M
TH1272226003	VPR 1/8" 22 6 PN RC CP M

DISTRIBUITOARE" VPR", 22mm - ACTIONARE PNEUMATICA, G=1/4

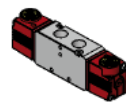

COD	REFERINTE
TH1272233001	VPR 1/4" 22 3 PN PM NC M
TH1272233002	VPR 1/4" 22 3 PN PM NO M
TH1272233003	VPR 1/4" 22 3 PN BS OO M
TH1272234004	VPR 1/4" 22 3 PN DF OO M
TH1272235001	VPR 1/4" 22 5 PN PM OO M
TH1272235002	VPR 1/4" 22 5 PN BS OO M
TH1272235003	VPR 1/4" 22 5 PN DF OO M
TH1272236001	VPR 1/4" 22 6 PN RC CC M
TH1272236002	VPR 1/4" 22 6 PN RC CA M
TH1272236003	VPR 1/4" 22 6 PN RC CP M

DISTRIBUITOARE" VMR" - 22mm - ACTIONATE CU MANETA, G=1/4



COD	REFERINTE
TH1272333001	VMR 1/4" 22 3 TA ML NC M
TH1272333002	VMR 1/4" 22 3 TA BS OO M
TH1272333004	VMR 1/4" 22 3 LV ML NC M
TH1272333005	VMR 1/4" 22 3 LV BS OO M
TH1272333006	VMR 1/4" 22 3 L9 ML NC M
TH1272333007	VMR 1/4" 22 3 L9 BS OO M
TH1272335001	VMR 1/4" 22 5 TA ML OO M
TH1272335002	VMR 1/4" 22 5 TA BS OO M
TH1272335003	VMR 1/4" 22 5 LV ML OO M
TH1272335004	VMR 1/4" 22 5 LV ML OO M
TH1272335005	VMR 1/4" 22 5 L9 ML OO M
TH1272335006	VMR 1/4" 22 5 L9 BS OO M
TH1272336001	VMR 1/4" 22 6 LV ST CC M
TH1272336002	VMR 1/4" 22 6 LV ST CA M
TH1272336003	VMR 1/4" 22 6 LV ST CP M
TH1272336004	VMR 1/4" 22 6 LV RC CC M
TH1272336005	VMR 1/4" 22 6 LV RC CA M
TH1272336006	VMR 1/4" 22 6 LV RC CP M
TH1272336007	VMR 1/4" 22 6 L9 ST CC M
TH1272336008	VMR 1/4" 22 6 L9 ST CA M
TH1272336009	VMR 1/4" 22 6 L9 ST CP M
TH1272336010	VMR 1/4" 22 6 L9 RC CC M
TH1272336011	VMR 1/4" 22 6 L9 RC CA M
TH1272336012	VMR 1/4" 22 6 L9 RC CP M
TH1272336013	VMR 1/4" 22 6 TA RC CC M
TH1272336014	VMR 1/4" 22 6 TA RC CA M
TH1272336015	VMR 1/4" 22 6 TA RC CP M

DISTRIBUITOARE" MER", 22mm - ACTIONARE MECANICA, G=1/4



COD	REFERINTE
TH1272433001	MER 1/4" 22 3 PU ML NC M
TH1272433002	MER 1/4" 22 3 PU ML NO M
TH1272433003	MER 1/4" 22 3 RL ML NC M
TH1272433004	MER 1/4" 22 3 RL ML NO M
TH1272433005	MER 1/4" 22 3 RU ML NC M
TH1272433006	MER 1/4" 22 3 RU ML NO M
TH1272435001	MER 1/4" 22 5 PU ML OO M
TH1272435002	MER 1/4" 22 5 RL ML NO M
TH1272435003	MER 1/4" 22 5 RU ML OO M
TH1272533001	MER 1/4" 22 3 PS PM NC M
TH1272533002	MER 1/4" 22 3 PS PM NO M
TH1272533003	MER 1/4" 22 3 RS PM NC M
TH1272533004	MER 1/4" 22 3 RS PM NO M
TH1272533005	MER 1/4" 22 3 RO PM NC M
TH1272533006	MER 1/4" 22 3 RO PM NO M
TH1272533007	MER 1/4" 22 3 PO PM NC M
TH1272533008	MER 1/4" 22 3 PO PM NO M
TH1272533009	MER 1/4" 22 3 PB PM NC M
TH1272533010	MER 1/4" 22 3 PB PM NO M
TH1272533011	MER 1/4" 22 3 LS PM NC M
TH1272533012	MER 1/4" 22 3 LS PM NO M
TH1272533013	MER 1/4" 22 3 AN PM NC M
TH1272533014	MER 1/4" 22 3 AN PM NO M
TH1272535001	MER 1/4" 22 5 PS PM OO M
TH1272535002	MER 1/4" 22 5 RS PM OO M
TH1272535003	MER 1/4" 22 5 RO PM OO M
TH1272535004	MER 1/4" 22 5 PO PM OO M
TH1272535005	MER 1/4" 22 5 PB PM OO M
TH1272535006	MER 1/4" 22 5 LS PM OO M
TH1272535007	MER 1/4" 22 5 AN PM OO M

DISTRIBUITOARE" MER", 22mm - ACTIONARE MECANICA, G=1/4



COD	REFERINTE
TH1272433007	MER 1/4 22 3 RLC ML NC M
TH1272433008	MER 1/4 22 3 RLC ML NO M
TH1272433009	MER 1/4 22 3 RUC ML NC M
TH1272433010	MER 1/4 22 3 RUC ML NO M
TH1272435006	MER 1/4 22 5 RLC ML OO M
TH1272435007	MER 1/4 22 5 RUC ML OO M

ACCESORII

SERIA 125 - 127

PLACA DE BAZA LINIE 125

COD	REFERINTE
TH1325A00002	PLACA DE BAZA STB 1/4" 22 2 POZ.
TH1325A00003	PLACA DE BAZA STB 1/4" 22 3 POZ.
TH1325A00004	PLACA DE BAZA STB 1/4" 22 4 POZ.
TH1325A00005	PLACA DE BAZA STB 1/4" 22 5 POZ.
TH1325A00006	PLACA DE BAZA STB 1/4" 22 6 POZ.
TH1325A00007	PLACA DE BAZA STB 1/4" 22 7 POZ.
TH1325A00008	PLACA DE BAZA STB 1/4" 22 8 POZ.
TH1325A00009	PLACA DE BAZA STB 1/4" 22 9 POZ.
TH1325A00010	PLACA DE BAZA STB 1/4" 22 10POZ.
TH1325A00013	kit de montaj



KIT DE MONTAJ

COD	REFERINTE
TH1325C00001	Kit de montaj



PLACA DE BAZA (modul de alimentare), G=1/4

COD	REFERINTE
TH1226C00002	placa de baza+fitinguri pentru 2 distribuitoare
TH1226C00003	placa de baza +fitinguri pentru 3 distribuitoare
TH1226C00004	placa de baza+fitinguri pentru 4 distribuitoare
TH1226C00005	placa de baza+fitinguri pentru 5 distribuitoare
TH1226C00006	placa de baza+fitinguri pentru 6 distribuitoare
TH1226C00007	placa de baza+fitinguri pentru 7 distribuitoare
TH1226C00008	placa de baza+fitinguri pentru 8 distribuitoare
TH1226C00009	Suport scurt pentru distribuitoare
TH1226C00010	Suport lung pentru distribuitoare



PLACA DE BAZA (modul de alimentare), G=1/8

COD	REFERINTE
TH1226C00012	placa de baza - 2 distribuitoare
TH1226C00013	placa de baza - 3 distribuitoare
TH1226C00014	placa de baza - 4 distribuitoare
TH1226C00015	placa de baza - 5 distribuitoare
TH1226C00016	placa de baza - 6 distribuitoare
TH1226C00017	placa de baza - 7 distribuitoare
TH1226C00018	placa de baza - 8 distribuitoare
TH1226C00019	Suport scurt pentru distribuitoare
TH1226C00020	Suport lung pentru distribuitoare



BOBINA 22mm

COD	REFERINTE
THA502600018	DC12V BOBINA
THA502600006	DC24V BOBINA
THA502600007	AC24V 50/60Hz BOBINA
THA502600008	AC110V 50/60Hz BOBINA
THA502600009	AC220V 50/60Hz BOBINA



CONECTOR

COD	REFERINTE
THA502600010	CONECTOR Sp. 22mm



CONECTOR CU LED 22mm

COD	REFERINTE
THA502600026	CONECTOR CU LED 22mm,24V
THA502600027	CONECTOR CU LED 22mm,115V
THA502600028	CONECTOR CU LED 22mm,230V





CONECTOR CU LED + CABLU 22mm

COD	REFERINTE
THA502600029	CONECTOR CU LED +CABLU 22mm,24V
THA502600030	CONECTOR CU LED+CABLU 22mm,115V
THA502600031	CONECTOR CU LED+CABLU 22mm,230V



CABLU CONECTOR MULTIPOLAR

	COD	PINS	IP	LUNGIMEA
	TH1601C00002	25	40	40
	TH1601C00003	25	40	40
	TH1601C00004	25	40	40
	TH1601C00006	25	65	65
	TH1601C00007	25	65	65
	TH1601C00008	25	65	65
	TH1601C00014	44	65	65
	TH1601C00015	44	65	65
	TH1601C00016	44	65	65

KIT DE FIXARE BATERIE

	COD	REFERINTA
	TH1601C00017	kit fixare picioare
	TH1601C00018	kit fixare sina

AMORTIZOARE DE ZGOMOT

	COD	REFERINTA
	TH1601A00064	Push-in Ø6mm
	TH1601A00065	Push-in Ø8 mm
	TH1601A00066	Push-in Ø12 mm

AMORTIZOARE DE ZGOMOT

	COD	REFERINTA
	TH391.01.18	1/8"
	TH391.01.38	3/8"

DOP

	COD	REFERINTA
	TH1531C00010	DOP DE SEPARARE

BUTOANE PENTRU DISTRIBUTIOARE DE PANOU

SELECTOR CU CHEIE

COD	REFERINTE
-----	-----------



TH1003A00031	RT201N SELECTOR (2 pozitii.)
--------------	------------------------------

SELECTOR CU MANETA ROTATIVA SCURTA

COD	REFERINTE
-----	-----------



TH1003A00032	RT300N SELECTOR (2 pozitii)
TH1003A00033	RT350N SELECTOR (2 pozitii, cu retur)
TH1003A00034	RT313N SELECTOR (3 pozitii)
TH1003A00035	RT383N SELECTOR (3 pozitii, cu intoarcere pe centru)

SELECTOR CU MANETA ROTATIVA LUNGA

COD	REFERINTE
-----	-----------



TH1003A00036	RT400N SELECTOR (2 pozitii)
TH1003A00037	RT450N SELECTOR (2 pozitii, cu retur)
TH1003A00038	RT413N SELECTOR (3 pozitii)
TH1003A00039	RT483N SELECTOR (3 pozitii, cu intoarcere pe centru)

PUSH BUTON (ingropat)

COD	REFERINTE
-----	-----------



TH1003A00040	RT010 PUSH BUTON
TH1003A00019	ALBASTRU (N°10 PCS)
TH1003A00020	GALBEN (N°10 PCS)
TH1003A00021	VERDE (N°10 PCS)
TH1003A00047	ALB (N°10 PCS)
TH1003A00048	NEGRU (N°10 PCS)
TH1003A00049	ROSU (N°10 PCS)

PUSH BUTON 40 mm

COD	REFERINTE
-----	-----------



TH1003A00041	RT050R BUTON
TH1003A00042	RT050N BUTON

PUSH BUTON LUNG 40 mm

COD	REFERINTE
-----	-----------



TH1003A00052	RT065R - 40 BUTON
--------------	-------------------

PUSH BUTON LUNG 60 mm

COD	REFERINTE
-----	-----------



TH1003A00057	RT065R - 60 BUTON
--------------	-------------------

MANETA MULTIDIRECTIONALA 60mm

COD	REFERINTE
-----	-----------



TH1003A00046	RT054R MANETA
--------------	---------------

EV	1/8"	18	3	SL	ML	NC	M
PRODUS							MATERIAL
EV - DISTRIBUITOARE - actiunare electrica							METAL - M
VP - DISTRIBUITOARE - actiunare pneumatica							VARIANTE
CONEXIUNI							NORMAL INCHIS - NC
1/8" = G1/8"							NORMAL DESCHIS - NO
1/4" = G1/4"							CENTRU INCHIS - CC
1/2" = G1/2"							CENTRU DESCHIS - CA
1/4" = G1/4"							PRESIUNEA IN CENTRU - CP
ISO1 = ISO 5599/1							5/2 - 00
DIMENSIUNI							REVENIRE
18 = 18 mm							ARC - ML
22 = 22 mm							PILOTATA - PM
30 = 30 mm							BISTABIL - BS
FUNCTII							FUNCTIONARE
3 = 3/2							PNEUMATIC - VP
5 = 5/2							ELECTROPNEUMATIC - SL
6 = 5/3							ELECTROPNEUMATIC ASISTAT - SA

DISTRIBUITOARE

SERIA 130 -1/2

DISTRIBUITOARE" EV", 30mm - ACTIONARE ELECTRICA, G=1/2



COD	REFERINTE
TH1304153001	EV 1/2" 30 3 SL PM NC M
TH1304153002	EV 1/2" 30 3 SL PM NO M
TH1304153003	EV 1/2" 30 3 SL BS OO M
TH1304153004	EV 1/2" 30 3 SA PM NC M
TH1304153005	EV 1/2" 30 3 SA PM NO M
TH1304153006	EV 1/2" 30 3 SA BS OO M
TH1304155001	EV 1/2" 30 5 SL PM OO M
TH1304155002	EV 1/2" 30 5 SL BS OO M
TH1304155003	EV 1/2" 30 5 SA PM OO M
TH1304155004	EV 1/2" 30 5 SA BS OO M
TH1304156001	EV 1/2" 30 6 SL RC CC M
TH1304156002	EV 1/2" 30 6 SL RC CA M
TH1304156003	EV 1/2" 30 6 SL RC CP M
TH1304156004	EV 1/2" 30 6 SA RC CC M
TH1304156005	EV 1/2" 30 6 SA RC CA M
TH1304156006	EV 1/2" 30 6 SA RC CP M

DISTRIBUITOARE" VP", 30mm - ACTIONARE PNEUMATICA, G=1/2



COD	REFERINTE
TH1304253001	VP 1/2" 30 3 PN PM NC M
TH1304253002	VP 1/2" 30 3 PN PM NO M
TH1304253003	VP 1/2" 30 3 PN BS OO M
TH1304255001	VP 1/2" 30 5 PN PM OO M
TH1304255002	VP 1/2" 30 5 PN BS OO M
TH1304256001	VP 1/2" 30 6 PN RC CC M
TH1304256002	VP 1/2" 30 6 PN RC CA M
TH1304256003	VP 1/2" 30 6 PN RC CP M

DISTRIBUITOARE "VM", 30mm - ACTIONATE CU MANETA, G=1/2



COD	REFERINTE
TH1304355005	VM 1/2" 30 5 L9 ML OO M
TH1304356010	VM 1/2" 30 5 L9 RC CC M
TH1304356011	VM 1/2" 30 5 L9 RC CA M
TH1304355006	VM 1/2" 30 5 L9 BS OO M
TH1304356007	VM 1/2" 30 6 L9 ST CC M
TH1304356008	VM 1/2" 30 6 L9 ST CA M

DISTRIBUITOARE"EV", 22mm - ACTIONARE ELECTRICA, G=1/4



COD	REFERINTE
TH1302133001	EV 1/4" 22 3 SL PM NC M
TH1302133002	EV 1/4" 22 3 SL PM NO M
TH1302133003	EV 1/4" 22 3 SL BS OO M
TH1302133004	EV 1/4" 22 3 SA PM NC M
TH1302133005	EV 1/4" 22 3 SA PM NO M
TH1302133006	EV 1/4" 22 3 SA BS OO M
TH1302135001	EV 1/4" 22 5 SL PM OO M
TH1302135002	EV 1/4" 22 5 SL BS OO M
TH1302135003	EV 1/4" 22 5 SA PM OO M
TH1302135004	EV 1/4" 22 5 SA BS OO M
TH1302136001	EV 1/4" 22 6 SL RC CC M
TH1302136002	EV 1/4" 22 6 SL RC CA M
TH1302136003	EV 1/4" 22 6 SL RC CP M
TH1302136004	EV 1/4" 22 6 SA RC CC M
TH1302136005	EV 1/4" 22 6 SA RC CA M
TH1302136006	EV 1/4" 22 6 SA RC CP M

DISTRIBUITOARE

SERIA 130

DISTRIBUITOARE "EV", 18mm - ACTIONARE ELECTRICA, G=1/8



COD	REFERINTE
TH1301123001	EV 1/8" 18 3 SL MP NC M
TH1301123002	EV 1/8" 18 3 SL MP NO M
TH1301123003	EV 1/8" 18 3 SL BS OO M
TH1301123004	EV 1/8" 18 3 SA MP NC M
TH1301123005	EV 1/8" 18 3 SA MP NO M
TH1301123006	EV 1/8" 18 3 SA BS OO M
TH1301125001	EV 1/8" 18 5 SL MP OO M
TH1301125002	EV 1/8" 18 5 SL BS OO M
TH1301125003	EV 1/8" 18 5 SA MP OO M
TH1301125004	EV 1/8" 18 5 SA BS OO M
TH1301126001	EV 1/8" 18 6 SL RC CC M
TH1301126002	EV 1/8" 18 6 SL RC CA M
TH1301126003	EV 1/8" 18 6 SL RC CP M
TH1301126004	EV 1/8" 18 6 SA RC CC M
TH1301126005	EV 1/8" 18 6 SA RC CA M
TH1301126006	EV 1/8" 18 6 SA RC CP M

DISTRIBUITOARE "VP"22mm - ACTIONARE PNEUMATICA,G=1/4

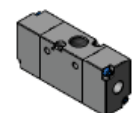

COD	REFERINTE
TH1302233001	VP 1/4" 22 3 PN PM NC M
TH1302233002	VP 1/4" 22 3 PN PM NO M
TH1302233003	VP 1/4" 22 3 PN BS OO M
TH1302235001	VP 1/4" 22 5 PN PM OO M
TH1302235002	VP 1/4" 22 5 PN BS OO M
TH1302236001	VP 1/4" 22 6 PN RC CC M
TH1302236002	VP 1/4" 22 6 PN RC CA M
TH1302236003	VP 1/4" 22 6 PN RC CP M

DISTRIBUITOARE" VP"18mm - ACTIONARE PNEUMATICA,G=1/8



COD	REFERINTE
TH1301223001	VP 1/8" 18 3 PN MP NC M
TH1301223002	VP 1/8" 18 3 PN MP NO M
TH1301223003	VP 1/8" 18 3 PN BS OO M
TH1301225001	VP 1/8" 18 5 PN MP OO M
TH1301225002	VP 1/8" 18 5 PN BS OO M
TH1301226001	VP 1/8" 18 6 PN RC CC M
TH1301226002	VP 1/8" 18 6 PN RC CA M
TH1301226003	VP 1/8" 18 6 PN RC CP M

DISTRIBUITOARE

SERIA 130

PLACA DE BAZA PENTRU DISTRIBUITOARE G=1/2



COD	REFERINTE
TH1345A00002	PLACA DE BAZA STB 1/2" 30 2 POS
TH1345A00003	PLACA DE BAZA STB 1/2" 30 3 POS
TH1345A00004	PLACA DE BAZA STB 1/2" 30 4 POS
TH1345A00005	PLACA DE BAZA STB 1/2" 30 5 POS
TH1345A00006	PLACA DE BAZA STB 1/2" 30 6 POS
TH1345A00007	PLACA DE BAZA STB 1/2" 30 7 POS
TH1345A00008	PLACA DE BAZA STB 1/2" 30 8 POS
TH1345A00009	PLACA DE BAZA STB 1/2" 30 9 POS
TH1345A00010	PLACA DE BAZA STB 1/2" 30 10POS



TH1345A00013 KIT PENTRU PLACA DE BAZA

PLACA DE BAZA PENTRU DISTRIBUITOARE G=1/4



COD	REFERINTE
TH1325A00002	PLACA DE BAZA STB 1/4" 22 2 POS
TH1325A00003	PLACA DE BAZA STB 1/4" 22 3 POS
TH1325A00004	PLACA DE BAZA STB 1/4" 22 4 POS
TH1325A00005	PLACA DE BAZA STB 1/4" 22 5 POS
TH1325A00006	PLACA DE BAZA STB 1/4" 22 6 POS
TH1325A00007	PLACA DE BAZA STB 1/4" 22 7 POS
TH1325A00008	PLACA DE BAZA STB 1/4" 22 8 POS
TH1325A00009	PLACA DE BAZA STB 1/4" 22 9 POS
TH1325A00010	PLACA DE BAZA STB 1/4" 22 10POS



TH1325A00013 KIT PENTRU PLACA DE BAZA

PLACA DE BAZA PENTRU DISTRIBUITOARE G=1/8



COD	REFERINTE
TH1315A00002	PLACA DE BAZA STB 1/8" 18 2 POS
TH1315A00003	PLACA DE BAZA STB 1/8" 18 3 POS
TH1315A00004	PLACA DE BAZA STB 1/8" 18 4 POS
TH1315A00005	PLACA DE BAZA STB 1/8" 18 5 POS
TH1315A00006	PLACA DE BAZA STB 1/8" 18 6 POS
TH1315A00007	PLACA DE BAZA STB 1/8" 18 7 POS
TH1315A00008	PLACA DE BAZA STB 1/8" 18 8 POS
TH1315A00009	PLACA DE BAZA STB 1/8" 18 9 POS
TH1315A00010	PLACA DE BAZA STB 1/8" 18 10POS

TH1315A00013 KIT PENTRU PLACA DE BAZA

BOBINA 22 mm



COD	REFERINTE
THA502600018	DC12V bobina
THA502600006	DC24V bobina
THA502600007	AC24V 50/60Hz bobina
THA502600008	AC110V 50/60Hz bobina
THA502600009	AC220V 50/60Hz bobina

CONECTOR



COD	REFERINTE
THA502600010	CONECTOR Sp. 22mm

CONECTOR CU LED + CABLU 22 mm



COD	REFERINTE
THA502600029	CONECTOR CU LED+CABLU, 22mm, 24V
THA502600030	CONECTOR CU LED+CABLU, 22mm, 115V
THA502600031	CONECTOR CU LED+CABLU, 22mm, 230V

CONECTOR CU LED 22 mm



COD	REFERINTE
THA502600026	CONECTOR CU LED 22mm, 24V
THA502600027	CONECTOR CU LED 22mm, 115V
THA502600028	CONECTOR CU LED 22mm, 230V

KIT PENTRU PLACA DE BAZA



COD	REFERINTE
TH1325C00001	KIT PENTRU PLACA DE BAZA

DISTRIBUITOARE

SERIA 130

PLACA DE BAZA (modul de alimentare), G=1/4

COD	REFERINTE
TH1226C00002	PLACA DE BAZA+FITINGURI-2 DISTRIBUITOARE
TH1226C00003	PLACA DE BAZA+FITINGURI-3 DISTRIBUITOARE
TH1226C00004	PLACA DE BAZA+FITINGURI-4 DISTRIBUITOARE
TH1226C00005	PLACA DE BAZA+FITINGURI-5 DISTRIBUITOARE
TH1226C00006	PLACA DE BAZA+FITINGURI-6 DISTRIBUITOARE
TH1226C00007	PLACA DE BAZA+FITINGURI-7 DISTRIBUITOARE
TH1226C00008	PLACA DE BAZA+FITINGURI-8 DISTRIBUITOARE



TH1226C00009 SUPORT SCURT PENTRU DISTRIBUITOARE



TH1226C00010 SUPORT LUNG PENTRU DISTRIBUITOARE

BOBINA 15 mm

COD	REFERINTE
TH1311A00002	BOBINA SP.17 DC 12V
TH1311A00001	BOBINA SP.17 DC 24V
TH1311A00006	BOBINA SP.17 AC 24V
TH1311A00007	BOBINA SP.17 AC 1100V
TH1311A00008	BOBINA SP.17 AC 220V



CONECTOR STANDARD 15mm

COD	REFERINTE
THA502600014	CONECTOR 15mm



CONECTOR CU LED+CABLU 15mm

COD	REFERINTE
THA502600023	CONECTOR CU LED+CABLU 15mm,24V
THA502600024	CONECTOR CU LED+CABLU 15mm,115V
THA502600025	CONECTOR CU LED+CABLU 15mm,230V



CONECTOR CU LED 15mm

COD	REFERINTE
THA502600020	CONECTOR CU LED 15mm 24V
THA502600021	CONECTOR CU LED 15mm,115V
THA502600022	CONECTOR CU LED 15mm,230v



DISTRIBUITOARE

LINIA 130 ISO

DISTRIBUITOARE ISO 5599/1

COD	REFERINTE
TH1308175001	EV ISO1 5 SL ML OO M
TH1308175002	EV ISO1 5 SL BS OO M
TH1308176001	EV ISO1 6 SL RC CC M
TH1308176002	EV ISO1 6 SL RC CA M
TH1308176003	EV ISO1 6 SL RC CP M



PLACA DE BAZA - MONTAJ SINGULAR

COD	REFERINTE
TH1355A0001	MONTAJ SINGULAR STB ISO1 orificii in partea laterala/inferiora



PLACA DE BAZA MULTIPLA

COD	REFERINTE
TH1355A00002	MODULAR STB ISO1 orificii in partea inferioara



PLACA DE BAZA - MONTAJ SINGULAR

COD	REFERINTE
TH1355A00005	MONTAJ SINGULAR STB ISO orificii in partea centrala



PLACA DE BAZA MULTIPLA

COD	REFERINTE
TH1355A00006	MULTIPLA STB ISO1 orificii in partea centrala



P140		G	1/4	5	B	PP
PRODUS						OPTIUNI (VARIANTE)
P140 - DISTRIBUITOARE TIP PEDALA SERIA 140						CU PROTECTIE - PP
						FARA PROTECTIE - M
TIP						OPTIUNI (VARIANTE)
G = PEDALA						BISTABILA - B
M = MICROPEDALA						MONOSTABILA - M
						MONOSTABILA CU SIGURANTA - S
CONEXIUNI						FUNCTII
1/4 = G1/4"						3/2 NC = 3
M5 = G1/4"						5/2 = 5
AU4 = RACORD AUTOMAT 4 mm CU CUPLE PUS-IN						MICROSWITCH NC+NO = 0
EL = ELECTRIC						

DISTRIBUITOARE

SERIA 130 NAMUR

DISTRIBUITOARE NAMUR - ACTIONARE ELECTRICA



COD	REFERINTE
TH1309135001	EV NM 5 SL ML 00 M
TH1309135002	EV NM 5 SL BS 00 M

BOBINA 30X30mm CU CABLU



COD	REFERINTE
TH1341A00001	BOBINA 30X30mm 24VDC CABLU L=3m

BOBINA 22mm



COD	REFERINTE
THA502600018	BOBINA 12VDC
THA502600006	BOBINA 24VDC
THA502600007	BOBINA 50/60Hz 24VAC
THA502600008	BOBINA 50/60Hz 110VAC
THA502600009	BOBINA 50/60Hz 220VAC

CONECTOR CU LED 22mm



COD	REFERINTE
THA502600026	CONECTOR CU LED 22mm, 24V
THA502600027	CONECTOR CU LED 22mm, 115V
THA502600028	CONECTOR CU LED 22mm, 230V

CONECTOR CU LED + CABLU 22mm



COD	REFERINTE
THA502600029	CONECTOR CU LED+CABLU 22mm, 24V
THA502600030	CONECTOR CU LED+CABLU 22mm, 115V
THA502600031	CONECTOR CU LED+CABLU 22mm, 230V

CONECTOR



COD	REFERINTE
THA502600010	CONECTOR Sp. 22mm

DISTRIBUITOARE

SERIA 130 - ACTIONARE MANUALA

DISTRIBUITOARE CU SERTAR ROTATIV - ACTIONARE MANUALA



COD	REFERINTE
TH1300334001	VM 1/4" 62 4 LR BS 00 M
TH1300337001	VM 1/4" 62 4A LR ST CC M
TH1300337002	VM 1/4" 62 4A LR ST CA M
TH1300354001	VM 1/2 74 4 LR BS 00 M
TH1300357001	VM 1/2 74 4A LR ST CC M
TH1300357002	VM 1/2 74 4A LR ST CA M
TH1300384001	VM 3/4 02 4 LR BS 00 M
TH1300387001	VM 3/4 02 4A LR ST CC M
TH1300387002	VM 3/4 02 4A LR ST CA M
TH1393A00001	NUT M33x1,5 for VM 1/4
TH1393A00002	NUT M40x1,5 for VM 1/2
TH1393A00003	NUT M50x1,5 for VM 3/4

DISTRIBUITOARE

SERIA 140 - PEDALE PNEUMATICE

PEDALE PNEUMATICE CU RETINERE-5/2 G1/4-3/2AU4



COD	REFERINTE
TH1407493001	P140 G AU4 3 M PP
TH1407493002	P140 G AU4 3 S PP
TH1407493003	P140 G AU4 3 B PP
TH1407535001	P140 G 1/4 5 M PP
TH1407535002	P140 G 1/4 5 S PP
TH1407535003	P140 G 1/4 5 B PP
TH1407535007	P140 G 1/4 5 M PP (carcasa portocalie)
TH1407535008	P140 G 1/4 5 S PP (carcasa portocalie)
TH1407535009	P140 G 1/4 5 B PP (carcasa portocalie)

PEDALE - ACTIONARE ELECTRICA



COD	REFERINTE
TH1407660801	P140 G EL O M PP
TH1407660802	P140 G EL O S PP
TH1499A00005	cablu pentru pedala electrica (IP65)

PEDALE PNEUMATICE FARA RETINERE - 5/2 G1/4



COD	REFERINTE
TH1407535004	P140 G 1/4 5 M SP
TH1407535005	P140 G 1/4 5 B SP

MINIPEDALE PNEUMATICE - 3/2Fl. 4mm - M5



COD	REFERINTE
TH1406493001	P140 M AU4 3 M SP
TH1406413001	P140 M M5 3 M SP

PLACA DE CAPAT STINGA (tab.1)

COD	REFERINTE	PILOTAREA CIRCUITELOR	CONTOR ELECTRIC	NUMAR POZITII
TH1501C00123	Placa de capat stinga G3/8	interna/externa	25 PIN	montaj in placa de baza - pina la 10 distribuitoare
TH1501C00124	Placa de capat stinga G3/8	interna/externa	44 PIN	montaj in placa de baza - 11 si 20 de distribuitoare
TH1501C00125	Placa de capat stinga AU12	interna/externa	25 PIN	montaj in placa de baza - pina la 10 distribuitoare
TH1501C00126	Placa de capat stinga AU12	interna/externa	44 PIN	montaj in placa de baza - 11 si 20 de distribuitoare



PLACA DE CAPAT DREAPTA (tab.2)

COD	REFERINTE	PILOTAREA CIRCUITELOR	CONTOR ELECTRIC	NUMAR POZITII
TH1501C00127	Placa de capat dreapta inchisa	interna/externa		multe
TH1501C00128	Placa de capat dreapta G3/8	interna/externa		multe
TH1501C00129	Placa de capat dreapta AU12	interna/externa		multe



2 BATERII SUPRAPUSE (tab. 3)

COD	REFERINTE	PILOTAREA CIRCUITELOR	CONTOR ELECTRIC	NUMAR POZITII
TH1501C00130	2 pozitii suprapuse			multe



PLACA DE BAZA MULTIPLA (tab.4)

COD	REFERINTE	CONECTARE	REF.	SCHEMA PNEUMATICA
TH1501C00001		1/4"	VA14	
TH1501C00002	EV 5/2 monostabil	AU8	VA08	
TH1501C00003		AU6	VA06	
TH1501C00004		1/4"	VB14	
TH1501C00005	EV 5/2 bistabil	AU8	VB08	
TH1501C00006		AU6	VB06	
TH1501C00007		1/4"	VC14	
TH1501C00008	EV 5/3 centru inchis	AU8	VC08	
TH1501C00009		AU6	VC06	
TH1501C00010		1/4"	VD14	
TH1501C00011	EV 3/2 NC + 3/2 NO	AU8	VD08	
TH1501C00012		AU6	VD06	
TH1501C00013		1/4"	VE14	
TH1501C00014	EV 3/2 NC + 3/2 NC	AU8	VE08	
TH1501C00015	(5/3 CA	AU6	VE06	
TH1501C00016	EV 3/2 NO + 3/2 NO	1/4"	VF14	
TH1501C00017	(5/3 CP)	AU8	VF08	
TH1501C00018		AU6	VF06	

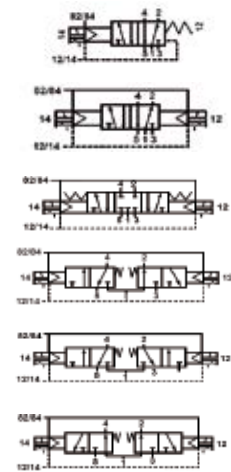

BLOC (tab.5)

COD	REFERINTE	CONECTARE	REF.	SCHEMA PNEUMATICA
TH1501C00025	pozitia modulului libera		MS	
TH1501C00026	alimentarea/	1/4"	MR14	
TH1501C00028	evacuare suplimentara	AU6	MR06	
TH1501C00027		AU8	MR08	

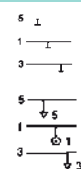

GHID DE REFERINTE

SERIA MP 160

MP160	5	025	B	VA8-VB8-MY8-VB8-VF6
PRODUS MP160 - BATERIE MODULARA SERIA 160				POZIȚIA MODULELOR VA8 - pos.1 VB8 - pos.2 MY8 - pos.3 VB8 - pos.4 VB8 - pos.5 VF8 - pos.2
NUMARUL TOTAL DE POZITII DE LA 2-16 5 = 5 POZITII				TIP ACȚIONARE ACȚIONARE PNEUMATICA - B
CONECTARE ELECTRICA 025 = SUB-D 25 poli SUB-D 25 pini 044 = SUB-D 44 poli SUB-D 44 pini CON = CABLU CONECTOR				

CONECTARE ELECTRICA



COMPONENTE BATERIE MODULARA

SERIA MP 160

BATERIE MODULARA		EXEMPLU	
1		POZITII	DESCRIERE
		2 POZITII	10 POZITII
		3 POZITII	11 POZITII
		4 POZITII	12 POZITII
		5 POZITII	13 POZITII
		6 POZITII	14 POZITII
		7 POZITII	15 POZITII
		8 POZITII	16 POZITII
		9 POZITII	

BATERIE MODULARA CU PLACA DE CAPAT ACTIONARE PNEUMATICA		EXEMPLU	
2		REFERINTE	DESCRIERE
		A	INTRARE PRIN STANGA
			INTRARE PRIN DREAPTA INCHIS
		B	INTRARE PRIN STANGA
			INTRARE PRIN DREAPTA
		C	INTRARE PRIN STANGA +
	INTRARE PRIN DREAPTA INCHIS		
D	INTRARE PRIN STANGA		
	INTRARE PRIN STANGA +		

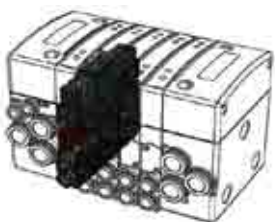
ELECTRODISTRIBUITOARE		EXEMPLU	
3		REFERINTE	DESCRIERE
		VA8	EV 5/2 MONOSTABIL - 8mm
		VB8	EV 5/2 BISTABIL - 8mm
		VC6	EV 5/2 MONOSTABIL - 8mm
		VD8	EV 5/2 MONOSTABIL - 8mm
		—	—
		—	—
MY8			

ACCESORII			
4			

MP160 4 025 B VA8-VB8-MY8-VD8

DISTRIBUITOARE

SERIA MP 160

BATERIE MODULARA



REFERINTE	DESCRIERE	CONECTARE ELECTRICA
2	2 pozitii	25 pini
3	3 pozitii	25 pini
4	4 pozitii	25 pini
5	5 pozitii	25 pini
6	6 pozitii	25 pini
7	7 pozitii	25 pini
8	8 pozitii	25 pini
9	9 pozitii	25 pini
10	10 pozitii	25 pini
11	11 pozitii	44 pini
12	12 pozitii	44 pini
13	13 pozitii	44 pini
14	14 pozitii	44 pini
15	15 pozitii	44 pini
16	16 pozitii	44 pini

BATERIE MODULARA CU PLACA DE CAPAT-ACTIONARE PNEUMATICA











REFERINTE	DESCRIERE	
A	intrare dreapta inchis	
B	intrare prin stinga std intrare prin dreapta std	
C	intrarea prin stinga std+pilotare externa intrare dreapta inchis	
D	intrare prin stinga +pilotare externa intrare prin dreapta std	

ELECTRODISTRIBUITOARE



REFERINTE	DESCRIERE	Ø	SIMBOL
VA6	EV 5/2 monostabil - Ø6mm	6 mm	
VA8	EV 5/2 monostabil - Ø8mm	8 mm	
VB6	EV 5/2 bistabil - Ø6mm	6 mm	
VB8	EV 5/2 bistabil - Ø8mm	8 mm	
VC6	EV 5/3 CC - Ø6mm	6 mm	
VC8	EV 5/3 CC - Ø8mm	8 mm	
VD6	EV 2 X 3/2 NC+NO - Ø6 mm	6 mm	
VD8	EV 2 X 3/2 NC+NO - Ø8 mm	8 mm	
VE6	EV 2 X 3/2 NC+NC - Ø6 mm	6 mm	
VE8	EV 2 X 3/2 NC+NC - Ø8 mm	8 mm	
VF6	EV 2 X 3/2 NO+NO - Ø6 mm	6 mm	
VF8	EV 2 X 3/2 NO+NO - Ø8 mm	8 mm	
VG6	EV 3/2 NC Ø6 mm montaj singular	6 mm	
VG8	EV 3/2 NC Ø8 mm montaj singular	8 mm	
VH6	EV 3/2 NO Ø6 mm montaj singular	6 mm	
VH8	EV 3/2 NO Ø8 mm montaj singular	8 mm	

BLOC DE DISTRIBUITOARE

REFERINTE	DESCRIERE	Ø	SIMBOL	
	MZ6	alimentare - deschis dreapta si evacuare -	6mm	
	MZ8	inchis stanga	8mm	
	MY6	alimentare - deschis stanga si evacuare -	6mm	
	MY8	inchis dreapta	8mm	
MX	module separate pentru alimentare si evacuare			
MS	modul de spatiere			
	MW6	alimentare - deschis dreapta si evacuare -	6mm	
	MW8	inchis stanga	8mm	
	MV6	alimentare - deschis stanga si evacuare -	6mm	
	MV8	inchis dreapta	8mm	
	MU6	alimentare stanga si dreapta - deschis	6mm	
	MU8	dreapta si evacuare inchis stanga	8mm	
	MT6	alimentare stanga si dreapta - deschis	6mm	
	MT8	stanga si evacuare inchis dreapta	8mm	

ACCESORII

SERIA MP 160

CABLU CONECTOR MULTIPOLAR

COD	PINI	IP	LUNGIME
TH1601C00002	25	40	3 m
TH1601C00003	25	40	5 m
TH1601C00004	25	40	10 m
TH1601C00006	25	65	3 m
TH1601C00007	25	65	5 m
TH1601C00008	25	65	10 m
TH1601C00014	44	65	3 m
TH1601C00015	44	65	5 m
TH1601C00016	44	65	10 m

KIT DE FIXARE BATERIE

COD	DESCRIERE
TH1601C00017	kit de fixare pentru MP 160
TH1601C00018	kit de fixare DIN pentru MP 160

CONECTORI

COD	DESCRIERE
THA502600014	conector std 15 mm
THA502600020	conector cu led 15 mm
THA502600023	conector cu cablu si led 15 L=3m

AMORTIZOARE DE ZGOMOT

COD	DESCRIERE
TH1601A00064	Push-in Ø6mm
TH1601A00065	Push-in Ø8 mm
TH1601A00066	Push-in Ø12 mm

PIESE DE SCHIMB

KIT PENTRU BOBINA

COD	DESCRIERE	VALVE MODEL
TH1601C00157	kit bobina distribuitor 5/2	VA6-VA8-VB6-VB8
TH1601C00160	kit bobina distribuitor 5/3	VC6 - VC8
TH1601C00162	kit bobina distribuitor 2X3/2 NC NO	VD6 - VD8
TH1601C00164	kit bobina distribuitor 2X3/2 NC NC	VE6 - VE8
TH1601C00161	kit bobina distribuitor 2X3/2 NO NO	VF6 - VF8
TH1601C00165	kit bobina distribuitor 3/2 NO	VH6 - VH8
TH1601C00166	kit de schimb 2X3/2 NC	VG6 - VG8



BOBINA

COD	DESCRIERE
TH1601A00040	EV 3/2 NC 24VDC 1W



INDEXUL PRODUSELOR

p.72 MICROCILINDRI PNEUMATICI FILETANTI
SERIA 200

p.73 MICROCILINDRI ROTUNZI
SERIA 220

p.76 CILINDRI GHIDATI SERIA 220

p.78 MICROCILINDRI ROTUNZI INOX
SERIA 221



CILINDRI ACCESORII

p.79 CILINDRI ROTUNZI SERIA 222

p.81 CILINDRI CU CURSA SCURTA
SERIA 225

p.82 CILINDRI PNEUMATICI COMPACTI
SERIA 230

p.85 CILINDRI PNEUMATICI
SERIA 240

p.88 CILINDRI PNEUMATICI
SERIA 250

p.93 CILINDRI CU BLOCARE
SERIA 240/250

p.94 SENZORI MAGNETICI

p.95 ACCESORII PENTRU CILINDRI
SERIA 230/240/250



CILINDRI

SERIA 200

C200	MA	006	005	A	F	P
PRODUS						MATERIAL
C200 - CILINDRI SERIA 200						POLIURETAN - P
FUNCTII						TIP TIJA
MA = simpla actiune						TIJA FILETATA - F TIJA NEFILETATA - L
DIMENSIUNI						TIP
006 = ø6 mm 010 = ø10 mm 016 = ø16 mm						NONMAGNETIC - A
						CURSA
						5 mm = 005 10 mm = 010 15 mm = 015

CILINDRI

SERIA 200

MICROCILINDRI PNEUMATICI FILETATI

C200 MA diametru/cursa AFP

CURSA	6	10	16
TH5	C200 MA 006 005 AFP	C200 MA 010 005 AFP	C200 MA 016 005 AFP
TH10	C200 MA 006 010 AFP	C200 MA 010 010 AFP	C200 MA 016 010 AFP
TH15	C200 MA 006 015 AFP	C200 MA 010 015 AFP	C200 MA 016 015 AFP



MICROCILINDRI PNEUMATICI CU SIMPLA ACTIUNE

C200 MA diametru/cursa ALP

CURSA	6
TH5	C200 MA 005 ALP
TH10	C200 MA 010 ALP
TH15	C200 MA 015 ALP



CILINDRI

SERIA 220

C220	DE	008	050	A	I	P
PRODUS C220 - CILINDRI SERIA 220						MATERIAL POLIURETAN - P
FUNCTII MP = MICROCILINDRI CU SIMPLA ACTIUNE, TIJA LUNGA MA = MICROCILINDRI CU SIMPLA ACTIUNE, TIJA SCURTA DE = DUBLA ACTIUNE DA = DUBLA ACTIUNE AMORTIZARE SP = PRIN TIJA PISTONULUI (ORIFICII AXIALE) PB = CILINDRI CU BLOCARE						TIP TIJA AISI 303 OTEL INOXIDABIL - I
						TIP MAGNETIC - M NONMAGNETIC - A
						CURSA 50 mm = 050
DIMENSIUNI 008 = ø8 mm 010 = ø10 mm 012 = ø12 mm 016 = ø16 mm 020 = ø20 mm 025 = ø25 mm						

CILINDRI

SERIA 220

MINICILINDRU ROTUND ISO6432 DUBLA ACTIUNE NON MAGNETIC

C220 DE diametru/cursa AIP



CURSA	8	10	12	16	20	25
TH10	C220 DE 008 010 AIP	C220 DE 010 010 AIP	C220 DE 012 010 AIP	C220 DE 016 010 AIP	C220 DE 020 010 AIP	C220 DE 025 010 AIP
TH25	C220 DE 008 025 AIP	C220 DE 010 025 AIP	C220 DE 012 025 AIP	C220 DE 016 025 AIP	C220 DE 020 025 AIP	C220 DE 025 025 AIP
TH50	C220 DE 008 050 AIP	C220 DE 010 050 AIP	C220 DE 012 050 AIP	C220 DE 016 050 AIP	C220 DE 020 050 AIP	C220 DE 025 050 AIP
TH80	C220 DE 008 080 AIP	C220 DE 010 080 AIP	C220 DE 012 080 AIP	C220 DE 016 080 AIP	C220 DE 020 080 AIP	C220 DE 025 080 AIP
TH100	C220 DE 008 100 AIP	C220 DE 010 100 AIP	C220 DE 012 100 AIP	C220 DE 016 100 AIP	C220 DE 020 100 AIP	C220 DE 025 100 AIP
TH125			C220 DE 012 125 AIP	C220 DE 016 125 AIP	C220 DE 020 125 AIP	C220 DE 025 125 AIP
TH160			C220 DE 012 160 AIP	C220 DE 016 160 AIP	C220 DE 020 160 AIP	C220 DE 025 160 AIP
TH200			C220 DE 012 200 AIP	C220 DE 016 200 AIP	C220 DE 020 200 AIP	C220 DE 025 200 AIP
TH250				C220 DE 016 250 AIP	C220 DE 020 250 AIP	C220 DE 025 250 AIP
TH320					C220 DE 020 320 AIP	C220 DE 025 320 AIP
TH350					C220 DE 020 350 AIP	C220 DE 025 350 AIP
TH400					C220 DE 020 400 AIP	C220 DE 025 400 AIP
TH450						C220 DE 025 450 AIP
TH500						C220 DE 025 500 AIP

MINICILINDRU ISO6432 DUBLA-ACTIUNE, MAGNETIC

C220 DE diametru/cursa MIP



CURSA	8	10	12	16	20	25
TH10	C220 DE 008 010 MIP	C220 DE 010 010 MIP	C220 DE 012 010 MIP	C220 DE 016 010 MIP	C220 DE 020 010 MIP	C220 DE 025 010 MIP
TH25	C220 DE 008 025 MIP	C220 DE 010 025 MIP	C220 DE 012 025 MIP	C220 DE 016 025 MIP	C220 DE 020 025 MIP	C220 DE 025 025 MIP
TH50	C220 DE 008 050 MIP	C220 DE 010 050 MIP	C220 DE 012 050 MIP	C220 DE 016 050 MIP	C220 DE 020 050 MIP	C220 DE 025 050 MIP
TH80	C220 DE 008 080 MIP	C220 DE 010 080 MIP	C220 DE 012 080 MIP	C220 DE 016 080 MIP	C220 DE 020 080 MIP	C220 DE 025 080 MIP
TH100	C220 DE 008 100 MIP	C220 DE 010 100 MIP	C220 DE 012 100 MIP	C220 DE 016 100 MIP	C220 DE 020 100 MIP	C220 DE 025 100 MIP
TH125			C220 DE 012 125 MIP	C220 DE 016 125 MIP	C220 DE 020 125 MIP	C220 DE 025 125 MIP
TH160			C220 DE 012 160 MIP	C220 DE 016 160 MIP	C220 DE 020 160 MIP	C220 DE 025 160 MIP
TH200			C220 DE 012 200 MIP	C220 DE 016 200 MIP	C220 DE 020 200 MIP	C220 DE 025 200 MIP
TH250				C220 DE 016 250 MIP	C220 DE 020 250 MIP	C220 DE 025 250 MIP
TH320					C220 DE 020 320 MIP	C220 DE 025 320 MIP
TH350					C220 DE 020 350 MIP	C220 DE 025 350 MIP
TH400					C220 DE 020 400 MIP	C220 DE 025 400 MIP
TH450						C220 DE 025 450 MIP
TH500						C220 DE 025 500 MIP

MINICILINDRU ROTUND ISO6432 DUBLA - ACTIUNE, AMORTIZARE LA CAPETE DE CURSA, NON-MAGNETIC

C220 DA diametru/cursa AIP



CURSA	16	20	25
TH25	C220 DA 016 025 AIP	C220 DA 020 025 AIP	C220 DA 025 025 AIP
TH50	C220 DA 016 050 AIP	C220 DA 020 050 AIP	C220 DA 025 050 AIP
TH80	C220 DA 016 080 AIP	C220 DA 020 080 AIP	C220 DA 025 080 AIP
TH100	C220 DA 016 100 AIP	C220 DA 020 100 AIP	C220 DA 025 100 AIP
TH125	C220 DA 016 125 AIP	C220 DA 020 125 AIP	C220 DA 025 125 AIP
TH160	C220 DA 016 160 AIP	C220 DA 020 160 AIP	C220 DA 025 160 AIP
TH200	C220 DA 016 200 AIP	C220 DA 020 200 AIP	C220 DA 025 200 AIP
TH250	C220 DA 016 250 AIP	C220 DA 020 250 AIP	C220 DA 025 250 AIP
TH320		C220 DA 020 320 AIP	C220 DA 025 320 AIP
TH350		C220 DA 020 350 AIP	C220 DA 025 350 AIP
TH400		C220 DA 020 400 AIP	C220 DA 025 400 AIP
TH450			C220 DA 025 450 AIP
TH500			C220 DA 025 500 AIP

MINICILINDRU ISO6432 DUBLA-ACTIUNE, AMORTIZARE LA CAPETE, DE CURSA, MAGNETIC

C220 DA diametru/cursa MIP

CURSA	16	20	25
TH25	C220 DA 016 025 MIP	C220 DA 020 025 MIP	C220 DA 025 025 MIP
TH50	C220 DA 016 050 MIP	C220 DA 020 050 MIP	C220 DA 025 050 MIP
TH80	C220 DA 016 080 MIP	C220 DA 020 080 MIP	C220 DA 025 080 MIP
TH100	C220 DA 016 100 MIP	C220 DA 020 100 MIP	C220 DA 025 100 MIP
TH125	C220 DA 016 125 MIP	C220 DA 020 125 MIP	C220 DA 025 125 MIP
TH160	C220 DA 016 160 MIP	C220 DA 020 160 MIP	C220 DA 025 160 MIP
TH200	C220 DA 016 200 MIP	C220 DA 020 200 MIP	C220 DA 025 200 MIP
TH250	C220 DA 016 250 MIP	C220 DA 020 250 MIP	C220 DA 025 250 MIP
TH320		C220 DA 020 320 MIP	C220 DA 025 320 MIP
TH350		C220 DA 020 350 MIP	C220 DA 025 350 MIP
TH400		C220 DA 020 400 MIP	C220 DA 025 400 MIP
TH450			C220 DA 025 450 MIP
TH500			C220 DA 025 500 MIP

FLANSA

Diametru	8 - 10	12 - 16	20 - 25
COD		COD	COD
	TH220A008005	TH220A012005	TH220A020005



TALPA

Diametru	8 - 10	12 - 16	20 - 25
COD		COD	COD
	TH220A008006	TH220A012006	TH220A020006



KIT TALPA ARTICULATA

Diametru	8 - 10	12 - 16	20 - 25
COD		COD	COD
	TH220A008007	TH220A012007	TH220A020007



ATASAMENT TIJA, TIP FURCA

Diametru	8 - 10	12 - 16	20	25
COD		COD	COD	COD
	TH220A008001	TH220A012001	TH220A020006	TH220A025002



CILINDRI

SERIA 220

CLAMA

Diametru	8 - 10	12 - 16	20	25
COD				
	TH220A008002	TH220A012002	TH220A020002	TH220A025002



CUPLAJ CU ARTICULATIE SFERICA

Diametru	8 - 10	12 - 16	20	25
COD				
	TH220A008003	TH220A012003	TH220A020003	TH220A025003



PIULITA ISO 6432

Diametru	Piulita pentru cilindru tip		
	8 - 10	12 - 16	20 - 25
COD			
	TH220A008004	TH220A012004	TH220A020004



Piston (mm)	8 - 10	12 - 16	20	25
COD				
	TH220A008011	TH220A012011	TH220A020011	TH240A032013

ARTICULATIE CILINDRICA

Diametru	12 - 16	20	25
COD			
	TH220A012008	TH220A020008	TH220A020006



CILINDRI GHIDATI H ISO 6432 , BUCSE CU ALUNECARE

UG220 H diametru/cursa B	Diametru	
CURSA	12 - 16	20 - 25
TH50	UG220 H 012 050 B	UG220 H 020 050 B
TH100	UG220 H 012 100 B	UG220 H 020 100 B
TH160	UG220 H 012 160 B	UG220 H 020 160 B
TH200	UG220 H 012 200 B	UG220 H 020 200 B
TH250	UG220 H 012 250 B	UG220 H 020 250 B
TH320	UG220 H 012 320 B	UG220 H 020 320 B
TH400	UG220 H 012 400 B	UG220 H 020 400 B
TH500	UG220 H 012 500 B	UG220 H 020 500 B



CILINDRI GHIDATI H ISO 6432, BUCSE CU BILE

UG220 H diametru/cursa S	Diametru	
	CURSA 12 - 16	20 - 25
50	UG220 H 012 050 S	UG220 H 020 050 S
TH100	UG220 H 012 100 S	UG220 H 020 100 S
TH160	UG220 H 012 160 S	UG220 H 020 160 S
TH200	UG220 H 012 200 S	UG220 H 020 200 S
TH250	UG220 H 012 250 S	UG220 H 020 250 S
TH320	UG220 H 012 320 S	UG220 H 020 320 S
TH400	UG220 H 012 400 S	UG220 H 020 400 S
TH500	UG220 H 012 500 S	UG220 H 020 500 S



CILINDRI GHIDATI U ISO 6432 , BUCSE CU ALUNECARE

UG220 U diametru/cursa B	Diametru	
	CURSA 12 - 16	20 - 25
TH50	UG220 U 012 050 B	UG220 U 020 050 B
TH100	UG220 U 012 100 B	UG220 U 020 100 B
TH160	UG220 U 012 160 B	UG220 U 020 160 B
TH200	UG220 U 012 200 B	UG220 U 020 200 B
TH250	UG220 U 012 250 B	UG220 U 020 250 B
TH320	UG220 U 012 320 B	UG220 U 020 320 B
TH400	UG220 U 012 400 B	UG220 U 020 400 B
TH500	UG220 U 012 500 B	UG220 U 020 500 B



MINICILINDRU CU BLOCARE

Diametru	20	25
COD	COD	
	TH220A020009	TH220A025009



SUPPORT PENTRU SENZOR MAGNETIC - SERIA 222

COD	Diametru
TH220A008010	Sursa magnetica pentru cilindru 8
TH220A001010	Sursa magnetica pentru cilindru 10
TH220A012010	Sursa magnetica pentru cilindru 12
TH220A016010	Sursa magnetica pentru cilindru 16
TH220A020010	Sursa magnetica pentru cilindru 20
TH220A025010	Sursa magnetica pentru cilindru 25
TH222A032005	Sursa magnetica pentru cilindru 32
TH222A040005	Sursa magnetica pentru cilindru 40
TH222A050005	Sursa magnetica pentru cilindru 50
TH222A063005	Sursa magnetica pentru cilindru 63



CILINDRI

SERIA 221

MINICILINDRI DE INOX ISO 6432 , DUBLA - ACTIUNE, MAGNETICI

C221 DE diametru/cursa MIP

CURSA	BORE SIZE					
	16		20		25	
TH10	C221	DE 016 010 MIP	C221	DE 020 010 MIP	C221	DE 025 010 MIP
TH25	C221	DE 016 025 MIP	C221	DE 020 025 MIP	C221	DE 025 025 MIP
TH50	C221	DE 016 050 MIP	C221	DE 020 050 MIP	C221	DE 025 050 MIP
TH80	C221	DE 016 080 MIP	C221	DE 020 080 MIP	C221	DE 025 080 MIP
TH100	C221	DE 016 100 MIP	C221	DE 020 100 MIP	C221	DE 025 100 MIP
TH125	C221	DE 016 125 MIP	C221	DE 020 125 MIP	C221	DE 025 125 MIP
TH160	C221	DE 016 160 MIP	C221	DE 020 160 MIP	C221	DE 025 160 MIP
TH200	C221	DE 016 200 MIP	C221	DE 020 200 MIP	C221	DE 025 200 MIP
TH250	C221	DE 016 250 MIP	C221	DE 020 250 MIP	C221	DE 025 250 MIP
TH320	C221	DE 016 320 MIP	C221	DE 020 320 MIP	C221	DE 025 320 MIP



FLANSA INOX

Diametru	16	20 - 25
COD		COD
	TH221A016005	TH221A020005



TALPA INOX

Diametru	16	20 - 25
COD		COD
	TH221A016006	TH221A020006



KIT TALPA ARTICULATA INOX

Diametru	16	20 - 25
COD		COD
	TH221A016007	TH221A020007



PIULITA ISO 6432

Diametru	16	20 - 25	
COD		COD	
	TH221A016004	TH221A020004	
	16	20	25
COD		COD	COD
	TH221A016011	TH221A020011	TH221A025011



CILINDRU ROTUND, DUBLA - ACTIUNE, MAGNETIC

C222 DE diametru/cursa MCP

CURSA	32	40	50	63
TH10	C222 DE 032 010 MCP	C222 DE 040 010 MCP	C222 DE 050 010 MCP	C222 DE 063 010 MCP
TH25	C222 DE 032 025 MCP	C222 DE 040 025 MCP	C222 DE 050 025 MCP	C222 DE 063 025 MCP
TH50	C222 DE 032 050 MCP	C222 DE 040 050 MCP	C222 DE 050 050 MCP	C222 DE 063 050 MCP
TH80	C222 DE 032 080 MCP	C222 DE 040 080 MCP	C222 DE 050 080 MCP	C222 DE 063 080 MCP
TH100	C222 DE 032 100 MCP	C222 DE 040 100 MCP	C222 DE 050 100 MCP	C222 DE 063 100 MCP
TH125	C222 DE 032 125 MCP	C222 DE 040 125 MCP	C222 DE 050 125 MCP	C222 DE 063 125 MCP
TH160	C222 DE 032 160 MCP	C222 DE 040 160 MCP	C222 DE 050 160 MCP	C222 DE 063 160 MCP
TH200	C222 DE 032 200 MCP	C222 DE 040 200 MCP	C222 DE 050 200 MCP	C222 DE 063 200 MCP
TH250	C222 DE 032 250 MCP	C222 DE 040 250 MCP	C222 DE 050 250 MCP	C222 DE 063 250 MCP
TH320	C222 DE 032 320 MCP	C222 DE 040 320 MCP	C222 DE 050 320 MCP	C222 DE 063 320 MCP
TH400	C222 DE 032 400 MCP	C222 DE 040 400 MCP	C222 DE 050 400 MCP	C222 DE 063 400 MCP
TH500	C222 DE 032 500 MCP	C222 DE 040 500 MCP	C222 DE 050 500 MCP	C222 DE 063 500 MCP

CILINDRU ROTUND, DUBLA - ACTIUNE, CU AMORTIZARE LA CAPETE DE CURSA

C222 DA diametru/cursa MCP

CURSA	32	40	50	63
TH25	C222 DA 032 025 MCP	C222 DA 040 025 MCP	C222 DA 050 025 MCP	C222 DA 063 025 MCP
TH50	C222 DA 032 050 MCP	C222 DA 040 050 MCP	C222 DA 050 050 MCP	C222 DA 063 050 MCP
TH80	C222 DA 032 080 MCP	C222 DA 040 080 MCP	C222 DA 050 080 MCP	C222 DA 063 080 MCP
TH100	C222 DA 032 080 MCP	C222 DA 040 080 MCP	C222 DA 050 080 MCP	C222 DA 063 080 MCP
TH125	C222 DA 032 125 MCP	C222 DA 040 125 MCP	C222 DA 050 125 MCP	C222 DA 063 125 MCP
TH160	C222 DA 032 160 MCP	C222 DA 040 160 MCP	C222 DA 050 160 MCP	C222 DA 063 160 MCP
TH200	C222 DA 032 200 MCP	C222 DA 040 200 MCP	C222 DA 050 200 MCP	C222 DA 063 200 MCP
TH250	C222 DA 032 250 MCP	C222 DA 040 250 MCP	C222 DA 050 250 MCP	C222 DA 063 250 MCP
TH320	C222 DA 032 320 MCP	C222 DA 040 320 MCP	C222 DA 050 320 MCP	C222 DA 063 320 MCP
TH400	C222 DA 032 400 MCP	C222 DA 040 400 MCP	C222 DA 050 400 MCP	C222 DA 063 400 MCP
TH500	C222 DA 032 500 MCP	C222 DA 040 500 MCP	C222 DA 050 500 MCP	C222 DA 063 500 MCP

KIT TIP BALAMA PENTRU CILINDRU ROTUND

Diametru	32	40	50	63
COD	COD	COD	COD	COD
	TH222A032001	TH222A040001	TH222A050001	TH222A063001



TALPA

Diametru	32	40	50	63
COD	COD	COD	COD	COD
	TH222A032002	TH222A040002	TH222A050002	TH222A063002



CILINDRI

SERIA 222

KIT DE FIXARE ARTICULATIE

Diametru	32	40	50	63
COD				
	TH222A032003	TH222A040003	TH222A050003	TH222A063003



PIULITA

Diametru	32	40	50 - 63
COD			
	TH222A032004	TH222A040004	TH222A050004



PIULITA PENTRU FILETUL DE PE CAPACELE CILINDRULUI

Diametru	32	40	50 - 63
COD			
	TH240A032013	TH220A008004	TH220A012004



CUPLAJ CU ARTICULATIE SFERICA

Diametru	32	40	50 - 63
COD			
	TH240A 032 004	TH240A 040 004	TH240A 050 004



ATASAMENT TIJA, TIP FURCA

Diametru	32	40	50 - 63
COD			
	TH240A 032 002	TH240A 040 002	TH240A 040 002

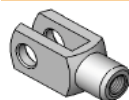

CLAMA

Diametru	32	40	50 - 63
COD			
	TH240A 032 003	TH240A 040 003	TH240A 050 003



C225	DE	016	050	M	I	N
PRODUS					MATERIALE SPECIALE	
C225 - CILINDRI SERIA 225					NBR - N VITON® - V	
FUNCTII					TIP TIJA	
DE - DUBLA ACTIUNE					OTEL INOXIDABIL - I	
SP - DUBLA ACTIUNE (AMORTIZARE LA CAPETE DE CURSA)						
MA - SIMPLA ACTIUNE					TIP	
AR - DUBLA ACTIUNE CU ANTIROTATIE					MAGNETIC - M	
DIMENSIUNI					CURSA	
016 = ø16 mm					5 mm = 005	
020 = ø20 mm						
025 = ø25 mm						

CILINDRU DUBLA - ACTIUNE, MAGNETIC, CURSA SCURTA

C225 DE diametru/cursa MIN	Diametru			
	CURSA	16	20	25
TH5	C225 DE 016 005 MIN	C225 DE 020 005 MIN	C225 DE 025 005 MIN	
TH10	C225 DE 016 010 MIN	C225 DE 020 010 MIN	C225 DE 025 010 MIN	
TH15	C225 DE 016 015 MIN	C225 DE 020 015 MIN	C225 DE 025 015 MIN	
TH20	C225 DE 016 020 MIN	C225 DE 020 020 MIN	C225 DE 025 020 MIN	
TH25	C225 DE 016 025 MIN	C225 DE 020 025 MIN	C225 DE 025 025 MIN	
TH30	C225 DE 016 030 MIN	C225 DE 020 030 MIN	C225 DE 025 030 MIN	
TH40	C225 DE 016 040 MIN	C225 DE 020 040 MIN	C225 DE 025 040 MIN	
TH50	C225 DE 016 050 MIN	C225 DE 020 050 MIN	C225 DE 025 050 MIN	

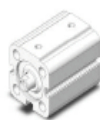

SENZOR MAGNETIC



CILINDRI

SERIA 230

C230	DE	032	050	M	I	P	—
PRODUS							FUNCTII SPECIALE
C230 - CILINDRI SERIA 230							TIJA - M
FUNCTII							MATERIAL
DE - DUBLA ACTIUNE							POLIURETAN - P
SP - PRIN TIJA PISTONULUI (ORIFICII AXIALE)							TIP TIJA
MA - SIMPLA ACTIUNE - TIJA SCURTA							OTEL INOXIDABIL - I
MP - SIMPLA ACTIUNE - TIJA LUNGA							TIP
DIMENSIUNI							MAGNETIC - M
032 = ø32 mm							NONMAGNETIC - A
040 = ø40 mm							CURSA
050 = ø50 mm							50 mm = 050
063 = ø63 mm							
080 = ø80 mm							
100 = ø100 mm							

CILINDRU COMPACT, DUBLA - ACTIUNE, MAGNETIC

C230 DE diametru/cursa MIP Diametru

CURSA	32	40	50	63	80	100
5	C230 DE 032 005 MIP	C230 DE 040 005 MIP	C230 DE 050 005 MIP	C230 DE 063 005 MIP	C230 DE 080 005 MIP	C230 DE 100 005 MIP
10	C230 DE 032 010 MIP	C230 DE 040 010 MIP	C230 DE 050 010 MIP	C230 DE 063 010 MIP	C230 DE 080 010 MIP	C230 DE 100 010 MIP
15	C230 DE 032 015 MIP	C230 DE 040 015 MIP	C230 DE 050 015 MIP	C230 DE 063 015 MIP	C230 DE 080 015 MIP	C230 DE 100 015 MIP
20	C230 DE 032 020 MIP	C230 DE 040 020 MIP	C230 DE 050 020 MIP	C230 DE 063 020 MIP	C230 DE 080 020 MIP	C230 DE 100 020 MIP
25	C230 DE 032 025 MIP	C230 DE 040 025 MIP	C230 DE 050 025 MIP	C230 DE 063 025 MIP	C230 DE 080 025 MIP	C230 DE 100 025 MIP
30	C230 DE 032 030 MIP	C230 DE 040 030 MIP	C230 DE 050 030 MIP	C230 DE 063 030 MIP	C230 DE 080 030 MIP	C230 DE 100 030 MIP
40	C230 DE 032 040 MIP	C230 DE 040 040 MIP	C230 DE 050 040 MIP	C230 DE 063 040 MIP	C230 DE 080 040 MIP	C230 DE 100 040 MIP
50	C230 DE 032 050 MIP	C230 DE 040 050 MIP	C230 DE 050 050 MIP	C230 DE 063 050 MIP	C230 DE 080 050 MIP	C230 DE 100 050 MIP
60	C230 DE 032 060 MIP	C230 DE 040 060 MIP	C230 DE 050 060 MIP	C230 DE 063 060 MIP	C230 DE 080 060 MIP	C230 DE 100 060 MIP
80	C230 DE 032 080 MIP	C230 DE 040 080 MIP	C230 DE 050 080 MIP	C230 DE 063 080 MIP	C230 DE 080 080 MIP	C230 DE 100 080 MIP
100	C230 DE 032 100 MIP	C230 DE 040 100 MIP	C230 DE 050 100 MIP	C230 DE 063 100 MIP	C230 DE 080 100 MIP	C230 DE 100 100 MIP
125	C230 DE 032 125 MIP	C230 DE 040 125 MIP	C230 DE 050 125 MIP	C230 DE 063 125 MIP	C230 DE 080 125 MIP	C230 DE 100 125 MIP
150	C230 DE 032 150 MIP	C230 DE 040 150 MIP	C230 DE 050 150 MIP	C230 DE 063 150 MIP	C230 DE 080 150 MIP	C230 DE 100 150 MIP
160	C230 DE 032 160 MIP	C230 DE 040 160 MIP	C230 DE 050 160 MIP	C230 DE 063 160 MIP	C230 DE 080 160 MIP	C230 DE 100 160 MIP
200	C230 DE 032 200 MIP	C230 DE 040 200 MIP	C230 DE 050 200 MIP	C230 DE 063 200 MIP	C230 DE 080 200 MIP	C230 DE 100 200 MIP
250	C230 DE 032 250 MIP	C230 DE 040 250 MIP	C230 DE 050 250 MIP	C230 DE 063 250 MIP	C230 DE 080 250 MIP	C230 DE 100 250 MIP
300	C230 DE 032 300 MIP	C230 DE 040 300 MIP	C230 DE 050 300 MIP	C230 DE 063 300 MIP	C230 DE 080 300 MIP	C230 DE 100 300 MIP



CILINDRU COMPACT, DUBLA - ACTIUNE, MAGNETIC, TIJA SPECIALA

C230 DE diametru/cursa MIPM Diametru

CURSA	32		40		50		63		80		100							
5	C230	DE 032 005	MIPM	C230	DE 040 005	MIPM	C230	DE 050 005	MIPM	C230	DE 063 005	MIPM	C230	DE 080 005	MIPM	C230	DE 100 005	MIPM
10	C230	DE 032 010	MIPM	C230	DE 040 010	MIPM	C230	DE 050 010	MIPM	C230	DE 063 010	MIPM	C230	DE 080 010	MIPM	C230	DE 100 010	MIPM
15	C230	DE 032 015	MIPM	C230	DE 040 015	MIPM	C230	DE 050 015	MIPM	C230	DE 063 015	MIPM	C230	DE 080 015	MIPM	C230	DE 100 015	MIPM
20	C230	DE 032 020	MIPM	C230	DE 040 020	MIPM	C230	DE 050 020	MIPM	C230	DE 063 020	MIPM	C230	DE 080 020	MIPM	C230	DE 100 020	MIPM
25	C230	DE 032 025	MIPM	C230	DE 040 025	MIPM	C230	DE 050 025	MIPM	C230	DE 063 025	MIPM	C230	DE 080 025	MIPM	C230	DE 100 025	MIPM
30	C230	DE 032 030	MIPM	C230	DE 040 030	MIPM	C230	DE 050 030	MIPM	C230	DE 063 030	MIPM	C230	DE 080 030	MIPM	C230	DE 100 030	MIPM
40	C230	DE 032 040	MIPM	C230	DE 040 040	MIPM	C230	DE 050 040	MIPM	C230	DE 063 040	MIPM	C230	DE 080 040	MIPM	C230	DE 100 040	MIPM
50	C230	DE 032 050	MIPM	C230	DE 040 050	MIPM	C230	DE 050 050	MIPM	C230	DE 063 050	MIPM	C230	DE 080 050	MIPM	C230	DE 100 050	MIPM
60	C230	DE 032 060	MIPM	C230	DE 040 060	MIPM	C230	DE 050 060	MIPM	C230	DE 063 060	MIPM	C230	DE 080 060	MIPM	C230	DE 100 060	MIPM
80	C230	DE 032 080	MIPM	C230	DE 040 080	MIPM	C230	DE 050 080	MIPM	C230	DE 063 080	MIPM	C230	DE 080 080	MIPM	C230	DE 100 080	MIPM
100	C230	DE 032 100	MIPM	C230	DE 040 100	MIPM	C230	DE 050 100	MIPM	C230	DE 063 100	MIPM	C230	DE 080 100	MIPM	C230	DE 100 100	MIPM
125	C230	DE 032 125	MIPM	C230	DE 040 125	MIPM	C230	DE 050 125	MIPM	C230	DE 063 125	MIPM	C230	DE 080 125	MIPM	C230	DE 100 125	MIPM
150	C230	DE 032 150	MIPM	C230	DE 040 150	MIPM	C230	DE 050 150	MIPM	C230	DE 063 150	MIPM	C230	DE 080 150	MIPM	C230	DE 100 150	MIPM
160	C230	DE 032 160	MIPM	C230	DE 040 160	MIPM	C230	DE 050 160	MIPM	C230	DE 063 160	MIPM	C230	DE 080 160	MIPM	C230	DE 100 160	MIPM
200	C230	DE 032 200	MIPM	C230	DE 040 200	MIPM	C230	DE 050 200	MIPM	C230	DE 063 200	MIPM	C230	DE 080 200	MIPM	C230	DE 100 200	MIPM
250	C230	DE 032 250	MIPM	C230	DE 040 250	MIPM	C230	DE 050 250	MIPM	C230	DE 063 250	MIPM	C230	DE 080 250	MIPM	C230	DE 100 250	MIPM
300	C230	DE 032 300	MIPM	C230	DE 040 300	MIPM	C230	DE 050 300	MIPM	C230	DE 063 300	MIPM	C230	DE 080 300	MIPM	C230	DE 100 300	MIPM



CILINDRI COMPACTI, MAGNETIC, (THROUGH-ROD)

C230 SP diametru/cursa MIP Diametru

CURSA	32		40		50		63		80		100							
5	C230	SP 032 005	MIP	C230	SP 040 005	MIP	C230	SP 050 005	MIP	C230	SP 063 005	MIP	C230	SP 080 005	MIP	C230	SP 100 005	MIP
10	C230	SP 032 010	MIP	C230	SP 040 010	MIP	C230	SP 050 010	MIP	C230	SP 063 010	MIP	C230	SP 080 010	MIP	C230	SP 100 010	MIP
15	C230	SP 032 015	MIP	C230	SP 040 015	MIP	C230	SP 050 015	MIP	C230	SP 063 015	MIP	C230	SP 080 015	MIP	C230	SP 100 015	MIP
20	C230	SP 032 020	MIP	C230	SP 040 020	MIP	C230	SP 050 020	MIP	C230	SP 063 020	MIP	C230	SP 080 020	MIP	C230	SP 100 020	MIP
25	C230	SP 032 025	MIP	C230	SP 040 025	MIP	C230	SP 050 025	MIP	C230	SP 063 025	MIP	C230	SP 080 025	MIP	C230	SP 100 025	MIP
30	C230	SP 032 030	MIP	C230	SP 040 030	MIP	C230	SP 050 030	MIP	C230	SP 063 030	MIP	C230	SP 080 030	MIP	C230	SP 100 030	MIP
40	C230	SP 032 040	MIP	C230	SP 040 040	MIP	C230	SP 050 040	MIP	C230	SP 063 040	MIP	C230	SP 080 040	MIP	C230	SP 100 040	MIP
50	C230	SP 032 050	MIP	C230	SP 040 050	MIP	C230	SP 050 050	MIP	C230	SP 063 050	MIP	C230	SP 080 050	MIP	C230	SP 100 050	MIP
80	C230	SP 032 080	MIP	C230	SP 040 080	MIP	C230	SP 050 080	MIP	C230	SP 063 080	MIP	C230	SP 080 080	MIP	C230	SP 100 080	MIP
100	C230	SP 032 100	MIP	C230	SP 040 080	MIP	C230	SP 050 100	MIP	C230	SP 063 100	MIP	C230	SP 080 100	MIP	C230	SP 100 100	MIP
125	C230	SP 032 125	MIP	C230	SP 040 125	MIP	C230	SP 050 125	MIP	C230	SP 063 125	MIP	C230	SP 080 125	MIP	C230	SP 100 125	MIP
150	C230	SP 032 150	MIP	C230	SP 040 150	MIP	C230	SP 050 150	MIP	C230	SP 063 150	MIP	C230	SP 080 150	MIP	C230	SP 100 150	MIP



SENZOR MAGNETIC



FLANSA CAPAC SPATE

230A diametru 001	Diametru				
32	40	50	63	80	100



CILINDRI

SERIA 230

BOLT PENTRU FLANSA CAPAC SPATE

230A diametru 010	Diametru				
32	40	50	63	80	100
230A 032 010	230A 040 010	230A 050 010	230A 063 010	230A 080 010	230A 100 010



TALPA PATRATA

230A diametru 002	Diametru				
32	40	50	63	80	100
230A 032 002	230A 040 002	230A 050 002	230A 063 002	230A 080 002	230A 100 002



TALPA DREPTUNGIULARA

230A diametru 002	Diametru				
32	40	50	63	80	100
230A 032 002	230A 040 002	230A 050 002	230A 063 002	230A 080 002	230A 100 002

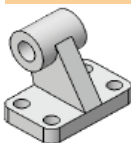

TALPA SCURTA

230A diametru 003	Diametru				
32	40	50	63	80	100
230A 032 003	230A 040 003	230A 050 003	230A 063 003	230A 080 003	230A 100 003



FLANSA FARA ARTICULATIE

230A diametru 004	Diametru				
32	40	50	63	80	100
230A 032 004	230A 040 004	230A 050 004	230A 063 004	230A 080 004	230A 100 004



FLANSA CU ARTICULATIE (DIN648K)

230A diametru 005	Diametru				
32	40	50	63	80	100
230A 032 005	230A 040 005	230A 050 005	230A 063 005	230A 080 005	230A 100 005



CILINDRI

SERIA 240 FI 32-100

C240	DE	032	0050	M	C	P
PRODUS						MATERIAL
C240 - CILINDRI SERIA 240						POLIURETAN - P NBR - N VITON - V
FUNCTII						TIP TIJA
DE = DUBLA ACTIUNE SP = PRIN TIJA PB - CU BLOCARE						OTEL INOXIDABIL - I CROM OTEL - C
DIMENSIUNI						TIP
032 = ø32 mm 040 = ø40 mm 050 = ø50 mm 063 = ø63 mm 080 = ø80 mm 100 = ø100 mm						MAGNETIC - M NONMAGNETIC - A
						CURSA
						50 mm = 0050

SERIA 240 FI 125-200

C240	DE	125	050	M	C	N
PRODUS						MATERIALE SPECIALE
C240 - CILINDRI SERIA 240						NBR - N
FUNCTII						TIP TIJA
DE = ACTIUNE DUBLA SP = PRIN TIJA PB - CU BLOCARE						CROM OTEL - C OTEL INOXIDABIL - I
DIMENSIUNI						TIP
125 = ø125 mm 160 = ø160 mm 200 = ø200 mm						MAGNETIC - M NONMAGNETIC - A
						CURSA
						50 mm = 050

CILINDRU PNEUMATIC STANDARD ISO 6431, DUBLA - ACTIUNE, DIAMETRE 125-160-200, NON-MAGNETIC

C240 DE diametru/cursa ACN	Diametru		
	CURSA	125	160
 25	C240 DE 125 025 ACN	C240 DE 160 025 ACN	C240 DE 200 025 ACN
50	C240 DE 125 050 ACN	C240 DE 160 050 ACN	C240 DE 200 050 ACN
80	C240 DE 125 080 ACN	C240 DE 160 080 ACN	C240 DE 200 080 ACN
100	C240 DE 125 100 ACN	C240 DE 160 100 ACN	C240 DE 200 100 ACN
125	C240 DE 125 125 ACN	C240 DE 160 125 ACN	C240 DE 200 125 ACN
150	C240 DE 125 150 ACN	C240 DE 160 150 ACN	C240 DE 200 150 ACN
160	C240 DE 125 160 ACN	C240 DE 160 160 ACN	C240 DE 200 160 ACN
200	C240 DE 125 200 ACN	C240 DE 160 200 ACN	C240 DE 200 200 ACN
250	C240 DE 125 250 ACN	C240 DE 160 250 ACN	C240 DE 200 250 ACN
300	C240 DE 125 300 ACN	C240 DE 160 300 ACN	C240 DE 200 300 ACN
320	C240 DE 125 320 ACN	C240 DE 160 320 ACN	C240 DE 200 320 ACN
350	C240 DE 125 350 ACN	C240 DE 160 350 ACN	C240 DE 200 350 ACN
400	C240 DE 125 400 ACN	C240 DE 160 400 ACN	C240 DE 200 400 ACN
450	C240 DE 125 450 ACN	C240 DE 160 450 ACN	C240 DE 200 450 ACN
500	C240 DE 125 500 ACN	C240 DE 160 500 ACN	C240 DE 200 500 ACN
600	C240 DE 125 600 ACN	C240 DE 160 600 ACN	C240 DE 200 600 ACN
700	C240 DE 125 700 ACN	C240 DE 160 700 ACN	C240 DE 200 700 ACN
800	C240 DE 125 800 ACN	C240 DE 160 800 ACN	C240 DE 200 800 ACN
900	C240 DE 125 900 ACN	C240 DE 160 900 ACN	C240 DE 200 900 ACN
1000	C240 DE 125 1000 ACN	C240 DE 160 1000 ACN	C240 DE 200 1000 ACN

CILINDRU PNEUMATIC STANDARD ISO 6431, DUBLA - ACTIUNE, DIAMETRE 125-160-200, MAGNETIC

C240 DE diametru/cursa MCN	Diametru		
	CURSA	125	160
 25	C240 DE 125 025 MCN	C240 DE 160 025 MCN	C240 DE 200 025 MCN
50	C240 DE 125 050 MCN	C240 DE 160 050 MCN	C240 DE 200 050 MCN
80	C240 DE 125 080 MCN	C240 DE 160 080 MCN	C240 DE 200 080 MCN
100	C240 DE 125 100 MCN	C240 DE 160 100 MCN	C240 DE 200 100 MCN
125	C240 DE 125 125 MCN	C240 DE 160 125 MCN	C240 DE 200 125 MCN
150	C240 DE 125 150 MCN	C240 DE 160 150 MCN	C240 DE 200 150 MCN
160	C240 DE 125 160 MCN	C240 DE 160 160 MCN	C240 DE 200 160 MCN
200	C240 DE 125 200 MCN	C240 DE 160 200 MCN	C240 DE 200 200 MCN
250	C240 DE 125 250 MCN	C240 DE 160 250 MCN	C240 DE 200 250 MCN
300	C240 DE 125 300 MCN	C240 DE 160 300 MCN	C240 DE 200 300 MCN
320	C240 DE 125 320 MCN	C240 DE 160 320 MCN	C240 DE 200 320 MCN
350	C240 DE 125 350 MCN	C240 DE 160 350 MCN	C240 DE 200 350 MCN
400	C240 DE 125 400 MCN	C240 DE 160 400 MCN	C240 DE 200 400 MCN
450	C240 DE 125 450 MCN	C240 DE 160 450 MCN	C240 DE 200 450 MCN
500	C240 DE 125 500 MCN	C240 DE 160 500 MCN	C240 DE 200 500 MCN
600	C240 DE 125 600 MCN	C240 DE 160 600 MCN	C240 DE 200 600 MCN
700	C240 DE 125 700 MCN	C240 DE 160 700 MCN	C240 DE 200 700 MCN
800	C240 DE 125 800 MCN	C240 DE 160 800 MCN	C240 DE 200 800 MCN
900	C240 DE 125 900 MCN	C240 DE 160 900 MCN	C240 DE 200 900 MCN
1000	C240 DE 125 1000 MCN	C240 DE 160 1000 MCN	C240 DE 200 1000 MCN

CILINDRI

SERIA 250

C250	DE	032	0050	M	I	P
PRODUS						MATERIALE SPECIALE
C250 - CILINDRI LINIA 250						POLIURETAN - P NBR - N VITON - V
FUNCTII						TIP TIJA
DE - CU ACTIUNE DUBLA SP - PRIN TIJA PB - CU BLOCARE						OTEL INOXIDABIL - I CROM OTEL - C
DIMENSIUNI						TIP
032 = ø32 mm 040 = ø40 mm 050 = ø50 mm 063 = ø63 mm 080 = ø80 mm 100 = ø100 mm						MAGNETIC - M NONMAGNETIC - A
						CURSA
						50 mm = 0050

CILINDRI

SERIA 250

CILINDRU PNEUMATIC ISO 6431-VDMA,DUBLA-ACTIUNE,TIJA DIN CROM, NON-MAGNETIC

C250 DE diametru/cursa ACP	Diametru								
	CURSA	32	40	50	63	80	100		
	25	C250 DE 032 025 ACP	C250 DE 040 025 ACP	C250 DE 050 025 ACP	C250 DE 063 025 ACP	C250 DE 080 025 ACP	C250 DE 100 025 ACP		
	50	C250 DE 032 050 ACP	C250 DE 040 050 ACP	C250 DE 050 050 ACP	C250 DE 063 050 ACP	C250 DE 080 050 ACP	C250 DE 100 050 ACP		
	75	C250 DE 032 075 ACP	C250 DE 040 075 ACP	C250 DE 050 075 ACP	C250 DE 063 075 ACP	C250 DE 080 075 ACP	C250 DE 100 075 ACP		
	80	C250 DE 032 080 ACP	C250 DE 040 080 ACP	C250 DE 050 080 ACP	C250 DE 063 080 ACP	C250 DE 080 080 ACP	C250 DE 100 080 ACP		
	100	C250 DE 032 100 ACP	C250 DE 040 100 ACP	C250 DE 050 100 ACP	C250 DE 063 100 ACP	C250 DE 080 100 ACP	C250 DE 100 100 ACP		
	125	C250 DE 032 125 ACP	C250 DE 040 125 ACP	C250 DE 050 125 ACP	C250 DE 063 125 ACP	C250 DE 080 125 ACP	C250 DE 100 125 ACP		
	150	C250 DE 032 150 ACP	C250 DE 040 150 ACP	C250 DE 050 150 ACP	C250 DE 063 150 ACP	C250 DE 080 150 ACP	C250 DE 100 150 ACP		
	160	C250 DE 032 160 ACP	C250 DE 040 160 ACP	C250 DE 050 160 ACP	C250 DE 063 160 ACP	C250 DE 080 160 ACP	C250 DE 100 160 ACP		
	200	C250 DE 032 200 ACP	C250 DE 040 200 ACP	C250 DE 050 200 ACP	C250 DE 063 200 ACP	C250 DE 080 200 ACP	C250 DE 100 200 ACP		
	250	C250 DE 032 250 ACP	C250 DE 040 250 ACP	C250 DE 050 250 ACP	C250 DE 063 250 ACP	C250 DE 080 250 ACP	C250 DE 100 250 ACP		
	300	C250 DE 032 300 ACP	C250 DE 040 300 ACP	C250 DE 050 300 ACP	C250 DE 063 300 ACP	C250 DE 080 300 ACP	C250 DE 100 300 ACP		
	320	C250 DE 032 320 ACP	C250 DE 040 320 ACP	C250 DE 050 320 ACP	C250 DE 063 320 ACP	C250 DE 080 320 ACP	C250 DE 100 320 ACP		
	350	C250 DE 032 350 ACP	C250 DE 040 350 ACP	C250 DE 050 350 ACP	C250 DE 063 350 ACP	C250 DE 080 350 ACP	C250 DE 100 350 ACP		
	400	C250 DE 032 400 ACP	C250 DE 040 400 ACP	C250 DE 050 400 ACP	C250 DE 063 400 ACP	C250 DE 080 400 ACP	C250 DE 100 400 ACP		
	450	C250 DE 032 450 ACP	C250 DE 040 450 ACP	C250 DE 050 450 ACP	C250 DE 063 450 ACP	C250 DE 080 450 ACP	C250 DE 100 450 ACP		
	500	C250 DE 032 500 ACP	C250 DE 040 500 ACP	C250 DE 050 500 ACP	C250 DE 063 500 ACP	C250 DE 080 500 ACP	C250 DE 100 500 ACP		
	600	C250 DE 032 600 ACP	C250 DE 040 600 ACP	C250 DE 050 600 ACP	C250 DE 063 600 ACP	C250 DE 080 600 ACP	C250 DE 100 600 ACP		
	700	C250 DE 032 700 ACP	C250 DE 040 700 ACP	C250 DE 050 700 ACP	C250 DE 063 700 ACP	C250 DE 080 700 ACP	C250 DE 100 700 ACP		
	800	C250 DE 032 800 ACP	C250 DE 040 800 ACP	C250 DE 050 800 ACP	C250 DE 063 800 ACP	C250 DE 080 800 ACP	C250 DE 100 800 ACP		
	900	C250 DE 032 900 ACP	C250 DE 040 900 ACP	C250 DE 050 900 ACP	C250 DE 063 900 ACP	C250 DE 080 900 ACP	C250 DE 100 900 ACP		
	1000	C250 DE 032 1000 ACP	C250 DE 040 1000 ACP	C250 DE 050 1000 ACP	C250 DE 063 1000 ACP	C250 DE 080 1000 ACP	C250 DE 100 1000 ACP		

FLANSA CAPAC SPATE

230A diametru 001	Diametru					
32	40	50	63	80	100	125
230A 032 001	230A 040 001	230A 050 001	230A 063 001	230A 080 001	230A 100 001	230A 125 001



BOLT PENTRU FLANSA CAPAC SPATE

230A diametru 010	Diametru					
32	40	50	63	80	100	125
230A 032 010	230A 040 010	230A 050 010	230A 063 010	230A 080 010	230A 100 010	230A 125 010



TALPA PATRATA

230A diametru 002	Diametru				
32	40	50	63	80	100
230A 032 002	230A 040 002	230A 050 002	230A 063 002	230A 080 002	230A 100 002



TALPA DREPTUNGIULARA

230A diametru 006	Diametru				
32	40	50	63	80	100
230A 032 006	230A 040 006	230A 050 006	230A 063 006	230A 080 006	230A 100 006

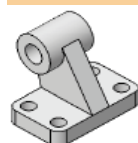

TALPA SCURTA

230A diametru 003	Diametru							
32	40	50	63	80	100	125	160	200
230A 032 003	230A 040 003	230A 050 003	230A 063 003	230A 080 003	230A 100 003	230A 125 003		



FLANSA FARA ARTICULATIE

230A diametru 004	Diametru							
32	40	50	63	80	100	125	160	200
230A 032 004	230A 040 004	230A 050 004	230A 063 004	230A 080 004	230A 100 004	230A 125 004		



CILINDRI

SERIA 240 - 250

FLANSA CU ARTICULATIE (DIN648K)

230A diametru 005	Diametru							
32	40	50	63	80	100	125	160	200
230A 032 005	230A 040 005	230A 050 005	230A 063 005	230A 080 005	230A 100 005	230A 125 005		



FLANSA DE FIXARE ISO

240A diametru 003	Diametru							
32	40	50	63	80	100	125	160	200



PRINDERE CENTRALA PENTRU CILINDRI STANDARD 240

240A diametru 010	Diametru							
32	40	50	63	80	100	125	160	
240A 032 010	240A 040 010	240A 050 010	240A 063 010	240A 080 010	240A 100 010	240A 125 010		



PLACA PENTRU ARTICULATIE

Diametru	32	40 - 50	63 - 80	100
COD	COD	COD	COD	COD
	TH240A 032 011	TH240A 040 011	TH240A 063 011	TH240A 100 011
	125	160		
COD	COD	COD		
	TH240A 125 011	TH240A 160 011		

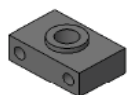

CUPLAJ CU ARTICULATIE SFERICA

Diametru	32	40 - 50	50 - 63	80 - 100
COD	COD	COD	COD	COD
	TH240A 032 004	TH240A 040 004	TH240A 050 004	TH240A 080 004
	125	160 - 200		
COD	COD	COD		
	TH240A 125 004	TH240A 160 004		



ATASAMENT TIJA, TIP FURCA

Diametru	32	40 - 50	50 - 63	80 - 100
COD	COD	COD	COD	COD
	TH240A 032 002	TH240A 040 002	TH240A 050 002	TH240A 080 002
	125	160 - 200		
COD	COD	COD		
	TH240A 125 002	TH240A 160 002		

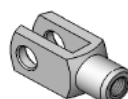

CLAME

Diametru	32	40	50 - 63	80 - 100
COD				
	TH240A 032 003	TH240A 040 003	TH240A 050 003	TH240A 080 003



BOLT

Diametru	125	160 - 200
COD		
	TH240A 125 003	TH240A 160 003

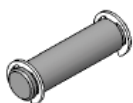

KIT DE FIXARE ARTICULATIE

Diametru	32	40	50 - 63	80 - 100
COD				
	TH240A 032 007	TH240A 040 007	TH240A 050 007	TH240A 080 007

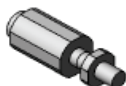

PIULITA PENTRU FILETUL DE PE CAPACELE CILINDRULUI

Diametru	32	40 - 50	50 - 63	80 - 100
COD				
	TH240A 032 013	TH220A 008004	TH220A 012004	TH240A 080 013
125		160 - 200		
COD		COD		
	TH240A 125 013	TH240A 160 013		



KIT PENTRU ASAMBLARE

COD	REFERINTE	LINE
TH250C 032 004	distribuitoare 120,125,127	250



CILINDRI

SERIA 240 - 250

CILINDRI GHIDATI H ISO 6431, BUCSE CU ALUNECARE

UG240 H Bore diametru/cursa B		Diametru					
CURSA	32	40	50	63	80	100	
50	UG240 H 032 050 B	UG240 H 032 050 B	UG240 H 050 050 B	UG240 H 063 050 B	UG240 H 080 050 B	UG240 H 100 050 B	
100	UG240 H 032 100 B	UG240 H 032 100 B	UG240 H 050 100 B	UG240 H 063 100 B	UG240 H 080 100 B	UG240 H 100 100 B	
160	UG240 H 032 160 B	UG240 H 032 160 B	UG240 H 050 160 B	UG240 H 063 160 B	UG240 H 080 160 B	UG240 H 100 160 B	
200	UG240 H 032 200 B	UG240 H 032 200 B	UG240 H 050 200 B	UG240 H 063 200 B	UG240 H 080 200 B	UG240 H 100 200 B	
250	UG240 H 032 250 B	UG240 H 032 250 B	UG240 H 050 250 B	UG240 H 063 250 B	UG240 H 080 250 B	UG240 H 100 250 B	
320	UG240 H 032 320 B	UG240 H 032 320 B	UG240 H 050 320 B	UG240 H 063 320 B	UG240 H 080 320 B	UG240 H 100 320 B	
400	UG240 H 032 400 B	UG240 H 032 400 B	UG240 H 050 400 B	UG240 H 063 400 B	UG240 H 080 400 B	UG240 H 100 400 B	
500	UG240 H 032 500 B	UG240 H 032 500 B	UG240 H 050 500 B	UG240 H 063 500 B	UG240 H 080 500 B	UG240 H 100 500 B	



CILINDRI GHIDATI H 6431, BUCSE CU BILE

CURSA		Diametru					
	32	40	50	63	80	100	
50	UG240 H 032 050 S	UG240 H 032 050 S	UG240 H 050 050 S	UG240 H 063 050 S	UG240 H 080 050 S	UG240 H 100 050 S	
100	UG240 H 032 100 S	UG240 H 032 100 S	UG240 H 050 100 S	UG240 H 063 100 S	UG240 H 080 100 S	UG240 H 100 100 S	
160	UG240 H 032 160 S	UG240 H 032 160 S	UG240 H 050 160 S	UG240 H 063 160 S	UG240 H 080 160 S	UG240 H 100 160 S	
200	UG240 H 032 200 S	UG240 H 032 200 S	UG240 H 050 200 S	UG240 H 063 200 S	UG240 H 080 200 S	UG240 H 100 200 S	
250	UG240 H 032 250 S	UG240 H 032 250 S	UG240 H 050 250 S	UG240 H 063 250 S	UG240 H 080 250 S	UG240 H 100 250 S	
320	UG240 H 032 320 S	UG240 H 032 320 S	UG240 H 050 320 S	UG240 H 063 320 S	UG240 H 080 320 S	UG240 H 100 320 S	
400	UG240 H 032 400 S	UG240 H 032 400 S	UG240 H 050 400 S	UG240 H 063 400 S	UG240 H 080 400 S	UG240 H 100 400 S	
500	UG240 H 032 500 S	UG240 H 032 500 S	UG240 H 050 500 S	UG240 H 063 500 S	UG240 H 080 500 S	UG240 H 100 500 S	

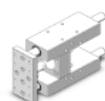

CILINDRI GHIDATI H ISO 6431, CURSE MAI MARI DE 500 mm

curse peste 500MM

	Diametre					
	32	40	50	63	80	100
BUCSE CU ALUNECARE	UG240 H 032...B	UG240 H 040 ...B	UG240 H 050 ...B	UG240 H 063 ...B	UG240 H 080 ...B	UG240 H 100 ...B
BUCSE CU BILE	UG240 H 032...S	UG240 H 040 ...S	UG240 H 040 ...S	UG240 H 063 ...S	UG240 H 080 ...S	UG240 H 100 ...S

CILINDRI GHIDATI U ISO 6432, BUCSE CU ALUNECARE

UG240 U diametru/cursa B		Diametru			
CURSA	32	40	50	63	
50	UG240 U 032 050 B	UG240 U 032 050 B	UG240 U 050 050 B	UG240 U 063 050 B	
100	UG240 U 032 100 B	UG240 U 032 100 B	UG240 U 050 100 B	UG240 U 063 100 B	
160	UG240 U 032 160 B	UG240 U 032 160 B	UG240 U 050 160 B	UG240 U 063 160 B	
200	UG240 U 032 200 B	UG240 U 032 200 B	UG240 U 050 200 B	UG240 U 063 200 B	
250	UG240 U 032 250 B	UG240 U 032 250 B	UG240 U 050 250 B	UG240 U 063 250 B	
320	UG240 U 032 320 B	UG240 U 032 320 B	UG240 U 050 320 B	UG240 U 063 320 B	
400	UG240 U 032 400 B	UG240 U 032 400 B	UG240 U 050 400 B	UG240 U 063 400 B	
500	UG240 U 032 500 B	UG240 U 032 500 B	UG240 U 050 500 B	UG240 U 063 500 B	



CILINDRI GHIDATI H ISO 6431, CURSE MAI MARI DE 500 mm

curse peste 500 mm	Diametru				
32	40	50	63	80	100
UG240 H 032....	UG240 H 040....	UG240 H 050....	UG240 H 063....	UG240 H 080....	UG240 H 100....



CILINDRU CU BLOCARE

240A diametru 012	Diametru				
32	40	50	63	80	100
240A 032 012	240A 040 012	240A 050 012	240A 063 012	240A 080 012	240A 100 012



SENZORI MAGNETICI

SENZOR REED, 2 FIRE, MAGNETIC, CU LACAS

COD	REFERINTE
TH230A000001	senzor reed, magnetic, 2 fire, 10-240V AC/DC, L=2,5m
TH230A000002	senzor reed, magnetic, 2 fire, 10-240V AC/DC, L=5m
TH230A000012	senzor reed, magnetic, 2 fire, 60VAC-70VAC, L=0,3m, mufa M8
TH230A000015	senzor reed, magnetic, 3 fire, 5-30VDC, L=2,5m
TH230A000016	senzor reed, magnetic, 3 fire, 5-30VDC, L=5m
TH230A000017	senzor reed, magnetic, 3 fire, 5-30V DC, L=0,3m, mufa M8



SENZOR REED, MAGNETIC

COD	REFERINTE
TH230A000003	senzor reed magnetic, 10-240V AC/DC(2fire), L=2,5m
TH230A000004	senzor reed magnetic, 10-240V AC/DC(2 fire), L=5m
TH230A000005	senzor reed magnetic, 60VAC-70DC(2 fire), mufa M8
TH230A000006	senzor reed magnetic, 5-30V DC(3 fire), L=2,5m
TH230A000007	senzor reed magnetic, 5-30 V DC(3 fire), L=5m
TH230A000008	senzor reed magnetic, 5-30VDC(3 fire), mufa M8, L=0,3m



MUFA M8

COD	REFERINTE
TH230A000009	mufa M8 pentru senzor reed, 3fire, L=3m
TH230A000010	mufa M8 pentru senzor reed, 3fire, L=5m
TH230A000011	mufa M8 pentru senzor reed, 3fire, L=10m



MUFE M8 PENTRU SISTEME MOBILE

COD	REFERINTE
TH230A000018	mufa M8 pentru senzor reed, 3fire, L=3m
TH230A000019	mufa M8 pentru senzor reed, 3fire, L=5m
TH230A000021	mufa M8 pentru senzor reed, 3fire, L=10m



SUPPORT DE PERETE PENTRU SENZOR REED MAGNETIC

COD	REFERINTE
TH230A032012	suport pentru senzor magnetic



SUPPORT DE MONTAJ SENZORI MAGNETICI PENTRU CILINDRI ISO 6431(LINIE 240)

COD	REFERINTE
TH240A032014	suport magnetic pt cilindri seria 240 diametre (32-40)
TH240A050031	suport magnetic pt cilindri seria 240 diametre (50-63)
TH240A080014	suport magnetic pt cilindri seria 240 diametre (80-100)
TH240A125008	suport magnetic pt cilindri seria 240 diametru 125
TH240A160008	suport magnetic pt cilindri seria 240 diametru 160



SUPPORT DE MONTAJ SENZORI MAGNETICI PENTRU CILINDRI ISO 6432(LINIE 220)

COD	REFERINTE
TH220A008010	suport magnetic pt cilindri ISO 6432, diametru 8
TH220A001010	suport magnetic pt cilindri ISO 6432, diametru 10
TH220A012010	suport magnetic pt cilindri ISO 6432, diametru 12
TH220A016010	suport magnetic pt cilindri ISO 6432, diametre 16
TH220A020010	suport magnetic pt cilindri ISO 6432, diametru 20
TH220A025010	suport magnetic pt cilindri ISO 6432, diametre 25



ACCESORII PENTRU CILINDRI

SUPORT DE MONTAJ SENZORI MAGNETICI PENTRU CILINDRI (SERIA 222)



COD	REFERINTE
TH222A032005	suport magnetic pentru cilindri diametru 32
TH222A040005	suport magnetic pentru cilindri diametru 40
TH222A050005	suport magnetic pentru cilindri diametru 50
TH222A063005	suport magnetic pentru cilindri diametru 63

KIT

SERIA 230

KIT DE MONTAJ PENTRU CILINDRI COMPACTI LINIE 230



DIAMETRU	COD (nemagnetic)	COD (magnetic)
32	TH230C032005	TH230C032004
40	TH230C040005	TH230C040004
50	TH230C050005	TH230C050004
63	TH230C063005	TH230C063004
80	TH230C080005	TH230C080004
100	TH230C100005	TH230C100004

KIT-UL CONTINE: capete technopolymer; sigiliu polyurethane; piston magnetic; suruburi de fixare 8 bucati

BARA PENTRU CILINDRI LINIE 250-230, PROFIL PATRAT L=3,20m



COD	DIAMETRU	REFERINTE
TH250A032002	32	Bara Linie 250 Ø 32
TH250A040002	40	Bara Linie 250 Ø 40
TH250A050002	50	Bara Linie 250 Ø 50
TH250A063002	63	Bara Linie 250 Ø 63
TH250A080002	80	Bara Linie 250 Ø 80
TH250A100002	100	Bara Linie 250 Ø 100

TIJA DE OTEL AISI 303 PENTRU CILINDRI ISO/COMPACTI, L=3m



COD	REFERINTE
TH240A032029	otel inoxidabil 12
TH240A040029	otel inoxidabil Ø 16
TH240A050029	otel inoxidabil Ø 20
TH240A080029	otel inoxidabil Ø 25

KIT

SERIA 240

KIT DE GARNITURI PENTRU CILINDRI LINIE 230/COMPACT



COD	DIAMETRU
TH230C032010	32
TH230C040010	40
TH230C050010	50
TH230C063010	63
TH230C080010	80
TH230C100010	100

KIT DE MONTAJ PENTRU CILINDRI ISO 15552 (ISO6431) SERIA 240



DIAMETRU	COD (nemagnetic)	COD (magnetic)
32	TH240C032003	TH230C032004
40	TH240C040003	TH230C040004
50	TH240C050003	TH230C050004
63	TH240C063003	TH230C063004
80	TH240C080003	TH230C080004
100	TH240C100003	TH230C100004

KIT-UL CONTINE: capete de amortizare reglabile; sigiliu; piston magnetic; suruburi de fixare 8 bucati

BARA PENTRU CILINDRU ISO 15552 SERIE 240 L=3,20 m



COD	DIAMETRU	REFERINTE
TH240A032030	32	Bara pt. Linie240 Ø 32
TH240A040030	40	Bara pt. Linie 240 Ø 40
TH240A050030	50	Bara pt. Linie 240 Ø 50
TH240A063030	63	Bara pt. Linie 240 Ø 63
TH240A080030	80	Bara pt. Linie 240 Ø 80
TH240A100030	100	Bara pt. Linie 240 Ø 100

TIJA PISTON CROM C45 PENTRU CILINDRI ISO/COMPACTI, L=3 m



COD	REFERINTE
TH240A032028	tija crom Ø 12
TH240A040028	tija crom Ø 16
TH240A050028	tija crom Ø 20
TH240A080028	tija crom Ø 25

KIT DE GARNITURI PENTRU CILINDRI ISO6431 (SERIA 240 si 250)



COD	DIAMETRU
TH240C032010	32
TH240C040010	40
TH240C050010	50
TH240C063010	63
TH240C080010	80
TH240C100010	100
TH240C125009	125 linie 240
TH240C160004	160 linie 240
TH240C200004	200 linie 240

TIJA INOX AISI 303 PENTRU CILINDRI ISO/COMPACTI, L=3m



COD	REFERINTE
TH240A032029	Tija inox Ø 12
TH240A040029	Tija inox Ø 16
TH240A050029	Tija inox Ø 20
TH240A080029	Tija inox Ø 25

KIT

SERIA 250

KIT PENTRU CILINDRI MAGNETICI ISO 6431-VDMA SERIA 250



DIAMETRU	COD (nemagnetic)	COD (magnetic)
32	TH250C032003	TH250C032002
40	TH250C040003	TH250C040002
50	TH250C050003	TH250C050002
63	TH250C063003	TH250C063002
80	TH250C080003	TH250C080002
100	TH250C100003	TH250C100002

KIT-UL CONTINE: capete technopolimer; sigili poluretani; piston magnetic; suruburi de fixare 8 bucati

BARA PENTRU CILINDRU ISO 6431-VDMA LINIE 250 PROFIL PATRAT - L=3,20 m



COD	DIAMETRU	REFERINTE
TH250A032002	32	Bara Linie 250 Ø 32
TH250A040002	40	Bara Linie 250 Ø 40
TH250A050002	50	Bara Linie 250 Ø 50
TH250A063002	63	Bara Linie 250 Ø 63
TH250A080002	80	Bara Linie 250 Ø 80
TH250A100002	100	Bara Linie 250 Ø 100

TIJA CROM C45 PENTRU CILINDRU ISO 6431-VDMA , L=3,00 m



COD	REFERINTE
TH240A032028	Tija crom Ø 12
TH240A040028	Tija crom Ø 16
TH240A050028	Tija crom Ø 20
TH240A080028	Tija crom Ø 25

TIJA INOX AISI 303 PENTRU CILINDRI ISO 6431-VDMA , L=3,00 m



COD	REFERINTE
TH240A032029	tija crom Ø 12
TH240A040029	tija crom Ø 16
TH240A050029	tija crom Ø 20
TH240A080029	tija crom Ø 25

KIT DE GARNITURI PENTRU CILINDRU ISO6431 (LINIE 240 si 250)



COD	DIAMETRU
TH240C032010	32
TH240C040010	40
TH240C050010	50
TH240C063010	63
TH240C080010	80
TH240C100010	100